

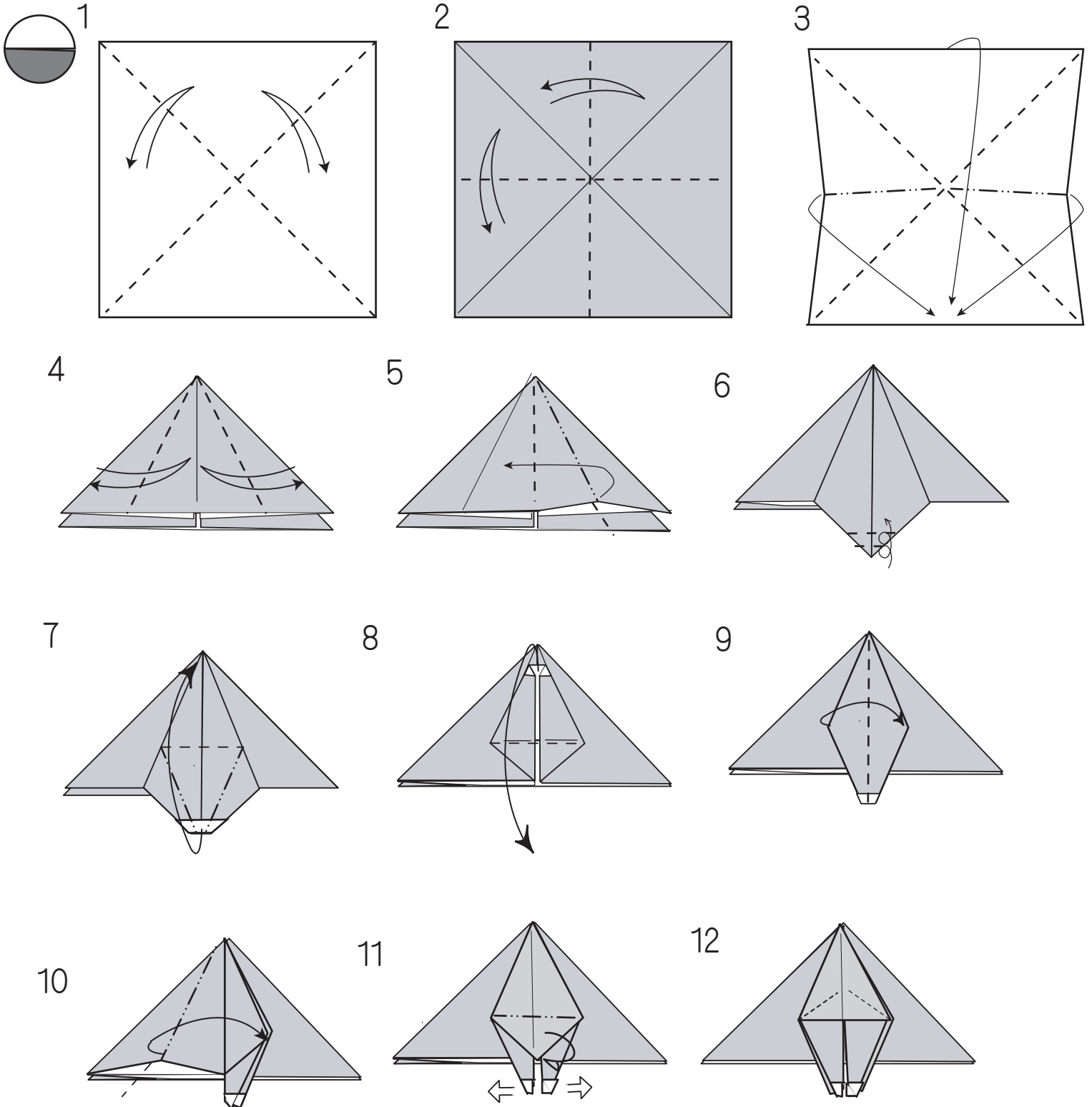

Cat wearing a facemask

(make a greeting card)



Repeat steps 5 - 9 on the left side.

13

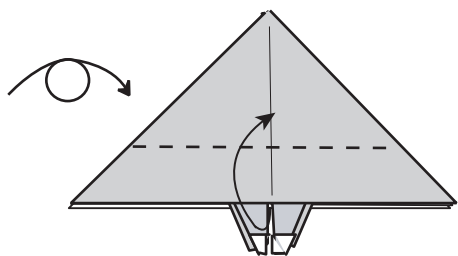

14

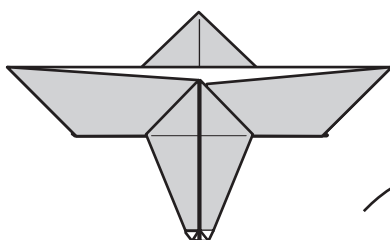

15

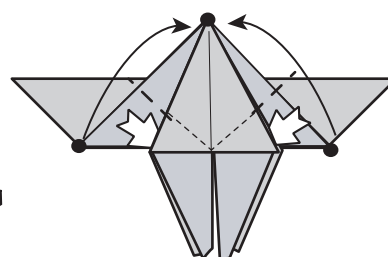

16

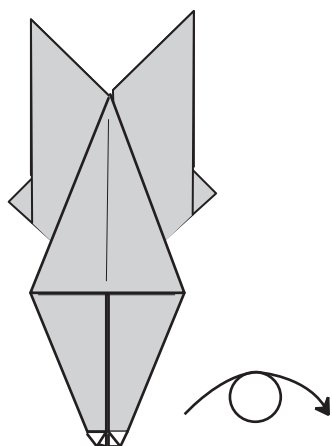

17

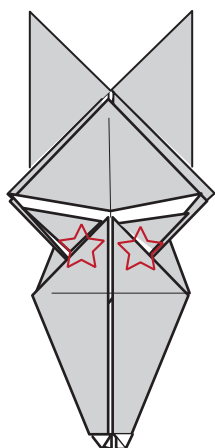

18

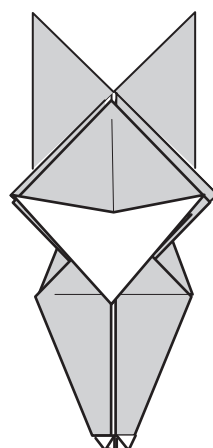

19

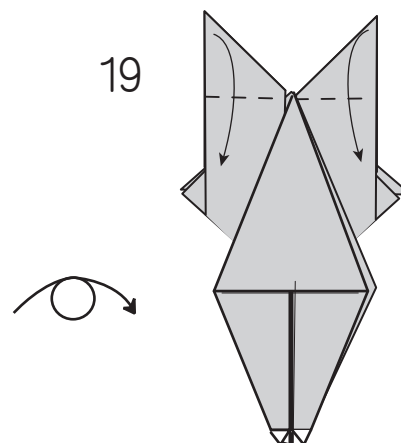

Tuck  under the white triangle.

20

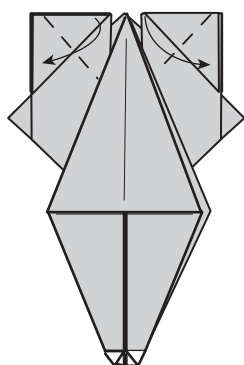

21

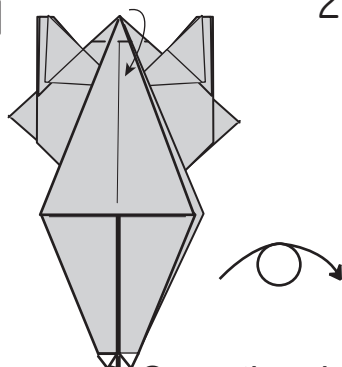

22

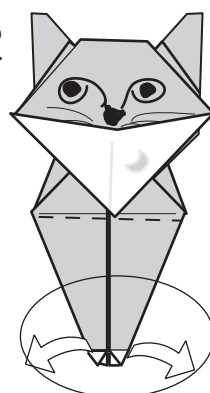

Open the sides and pull the white parts outward and press each into a pentagon.

