

テーマ 地球温暖化

Created by Shoko Aoyagi
Diagrams by Shoko Aoyagi

(おりがみ用紙2枚)

© Shoko Aoyagi

November 2008

上半身

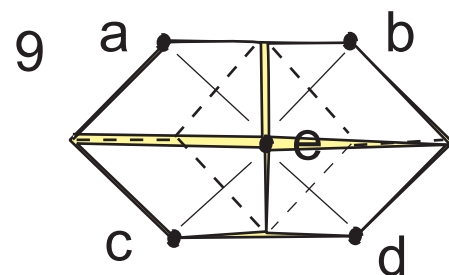
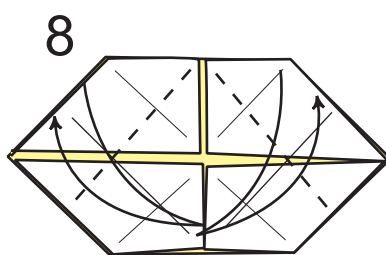
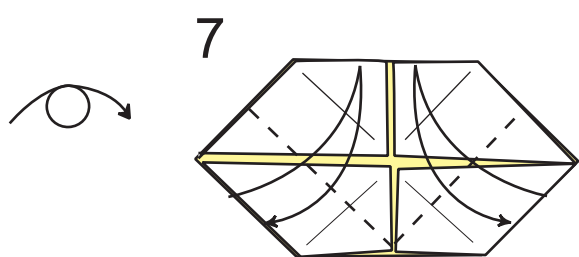
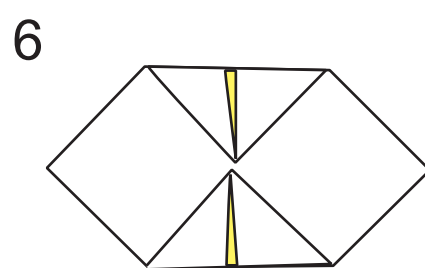
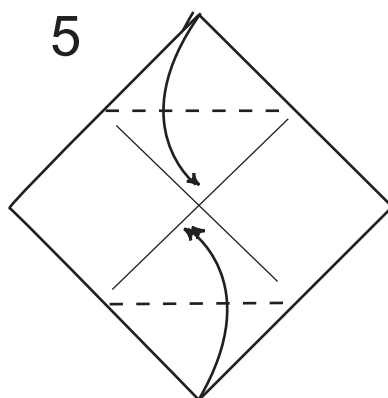
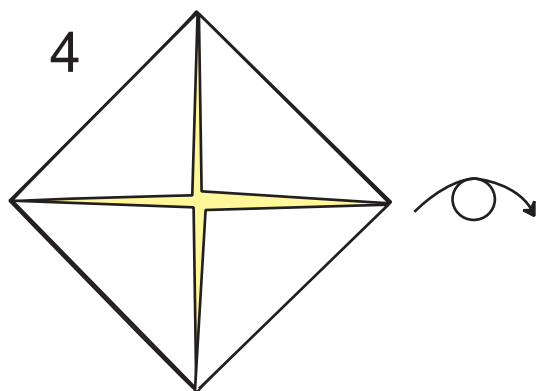
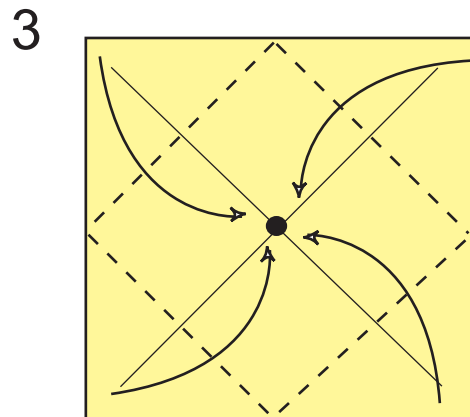
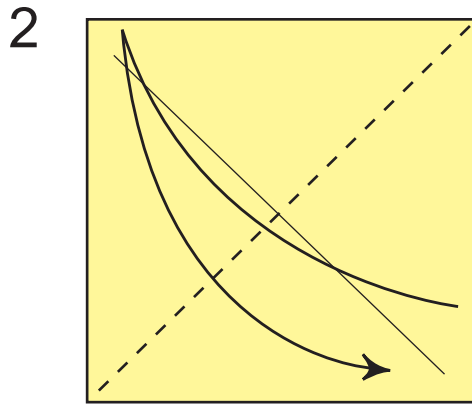
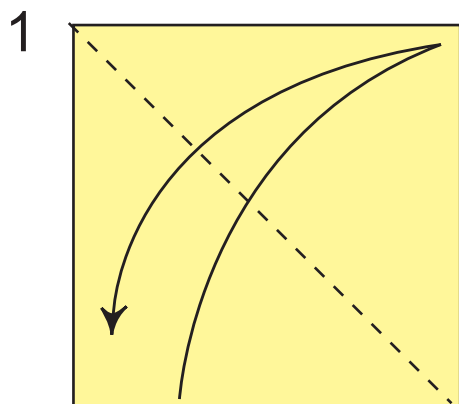

aとcをつまみ折。b
とdをつまみ折。

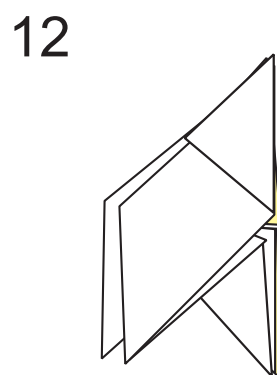
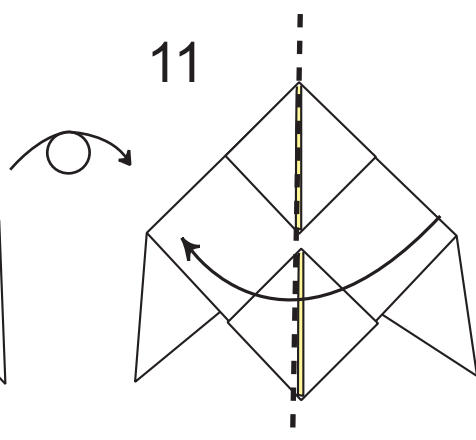
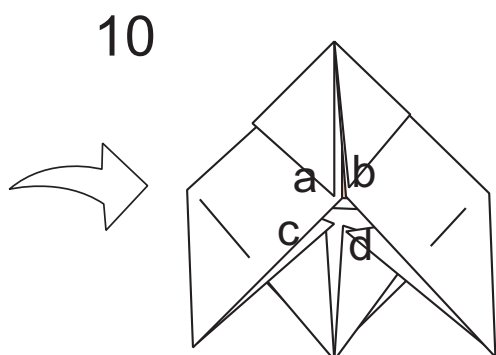

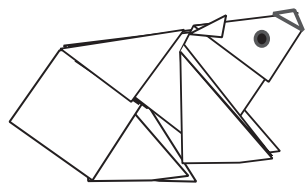

Created by Shoko Aoyagi
Diagrams by Shoko Aoyagi

© Shoko Aoyagi November 2008

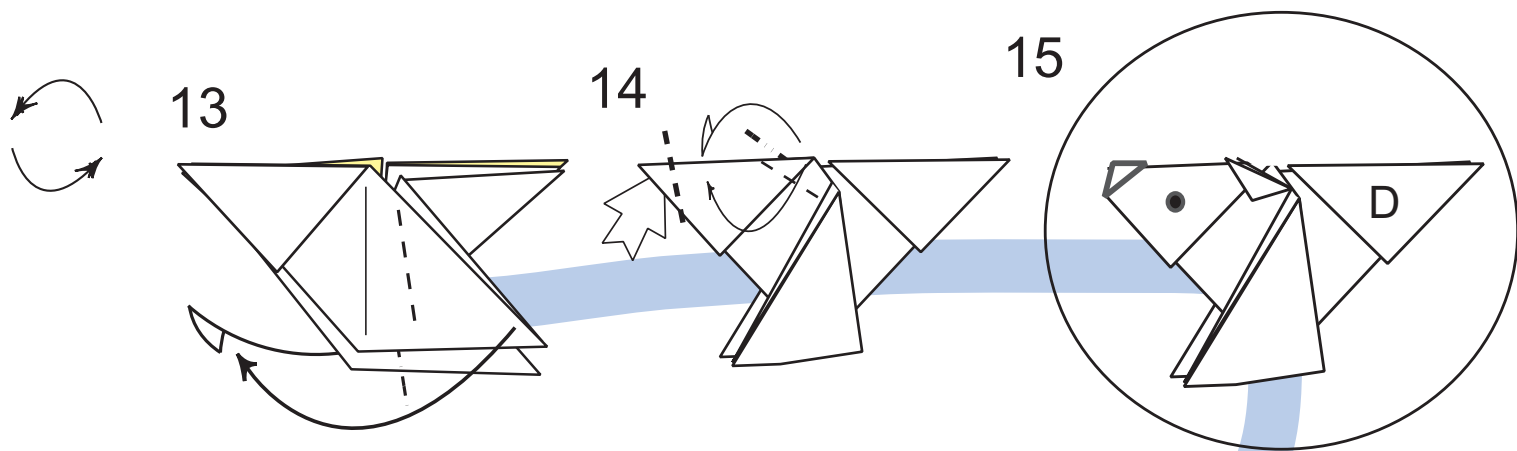

下半身

上半身の折り図10からスタート

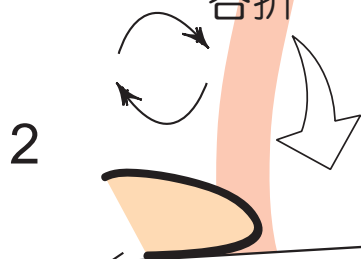
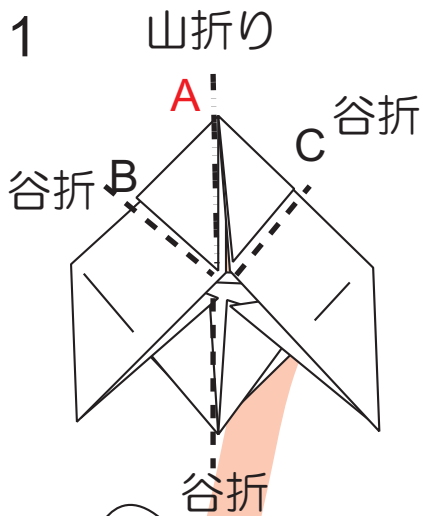
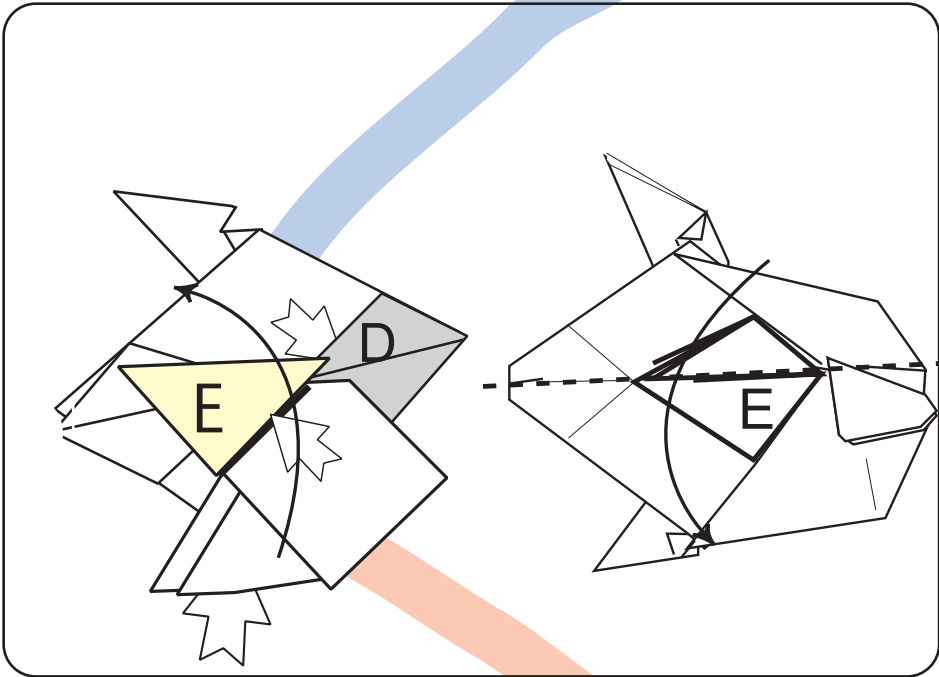

三角を半分に折る。

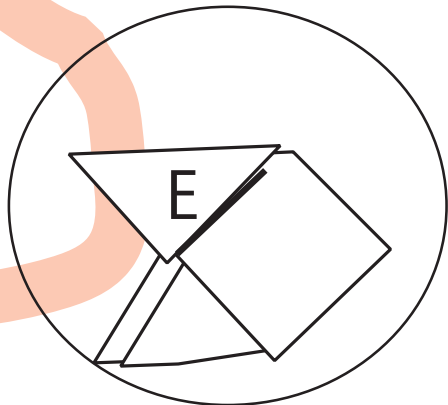
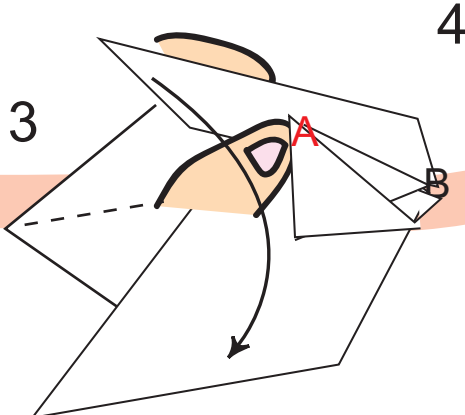

氷が足りない！

© Shoko Aoyagi November 2008

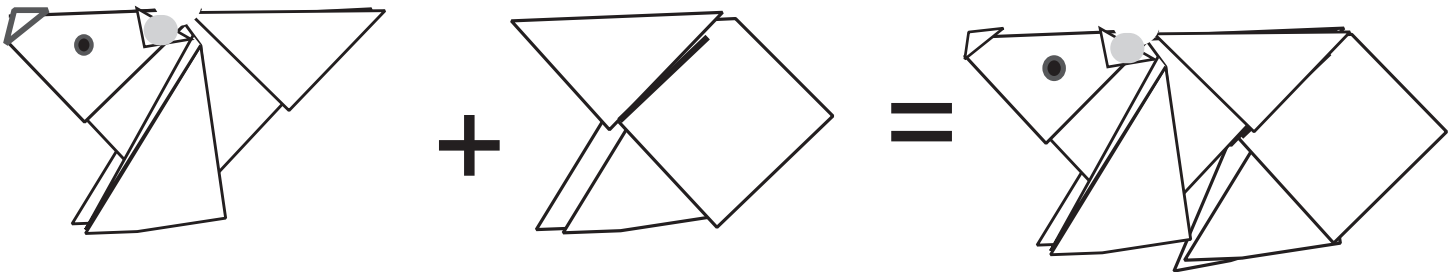
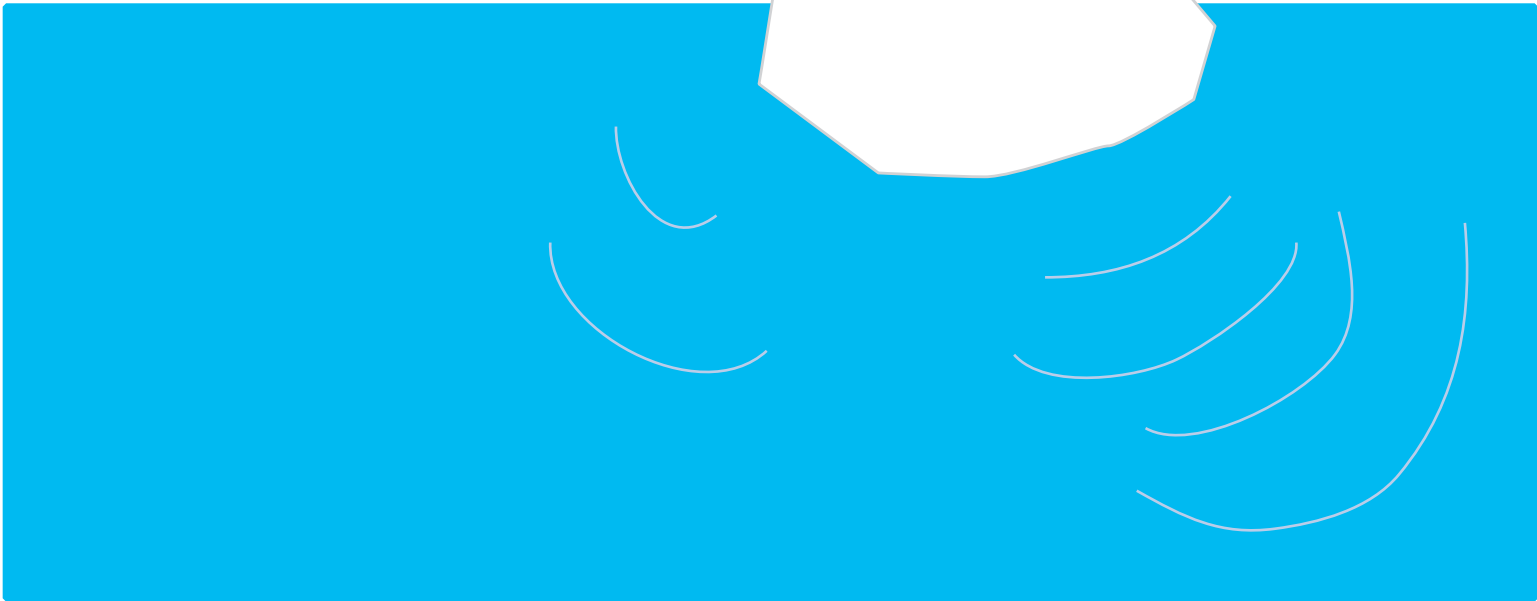

伝承のはかま2つでしろくまのこどもが
できます。