

牛のメッセージカード

Created by Shoko Aoyagi
Diagrams by Shoko Aoyagi

©Shoko Aoyagi 2004

おりがみ用紙 2枚

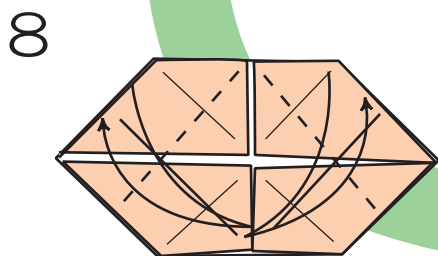
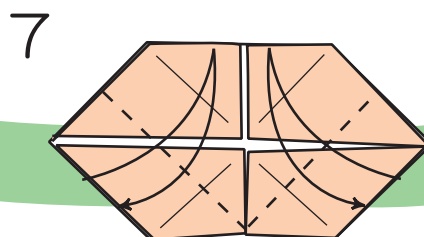
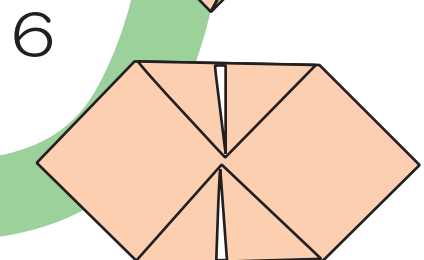
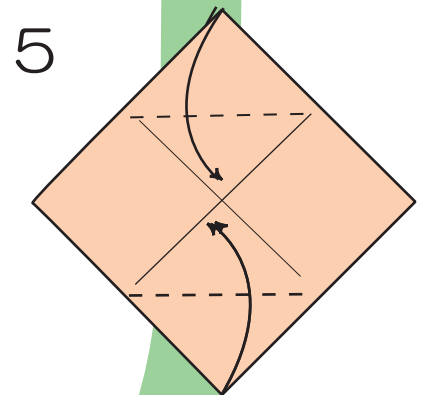
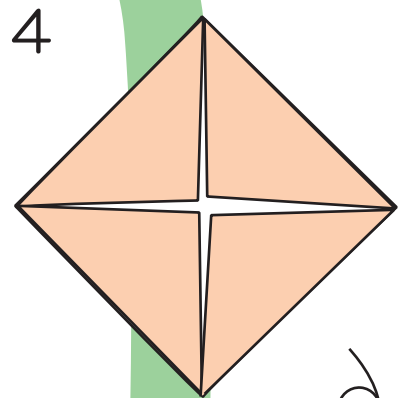
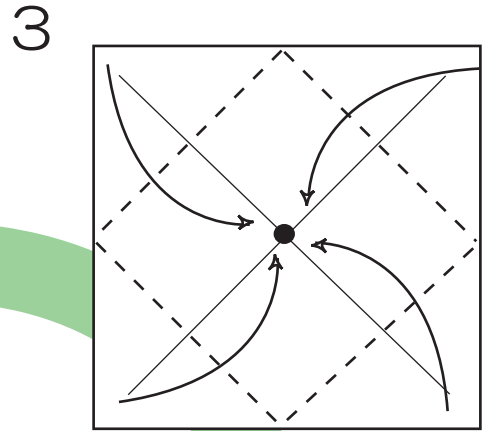
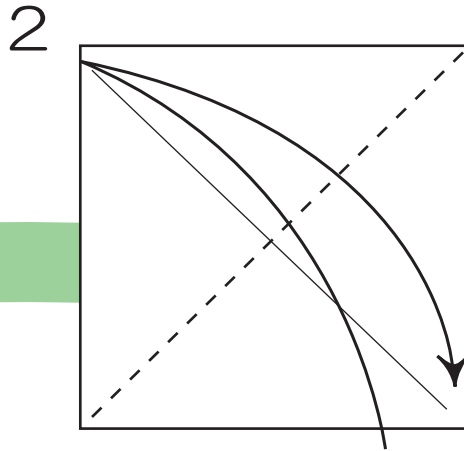
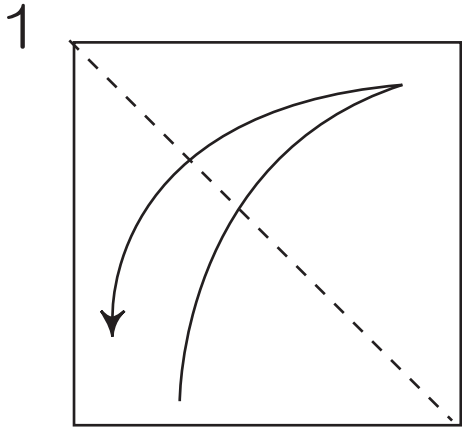
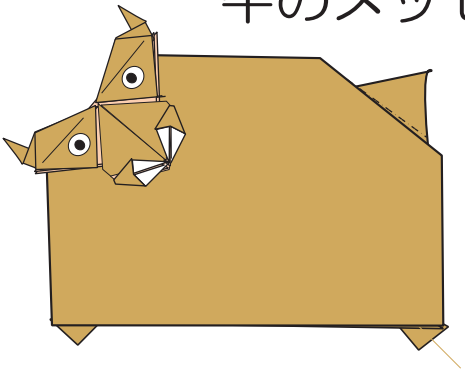

折線をしっかりつけて戻す。

折線をしっかりつけて戻す。

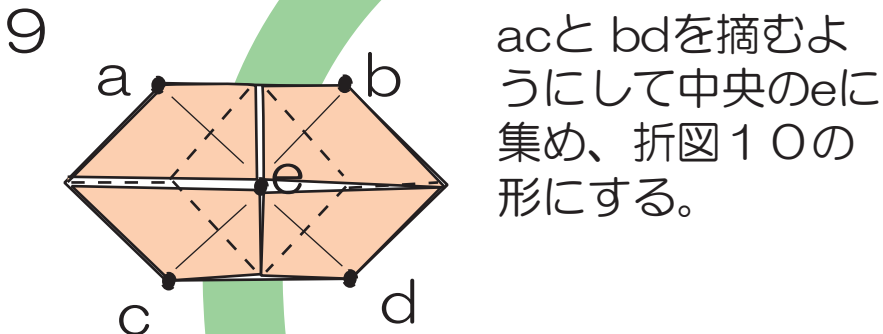

acとbdを掴むようにして中央のeに集め、折図10の形にする。

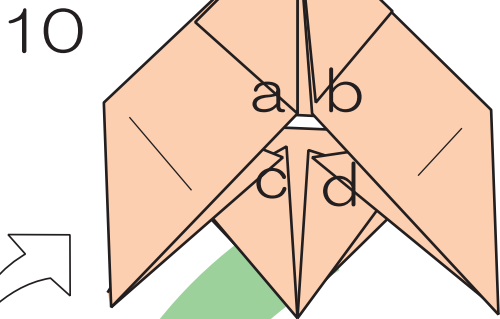

牛のメッセージカード

Created by Shoko Aoyagi
Diagrams by Shoko Aoyagi

©Shoko Aoyagi 2004

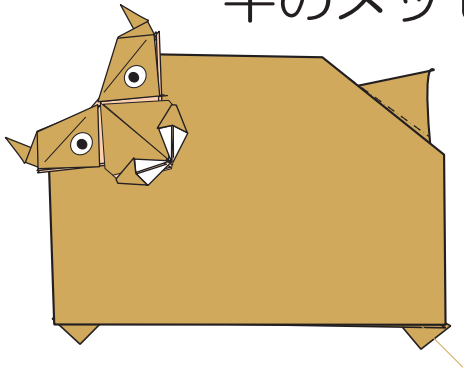

11

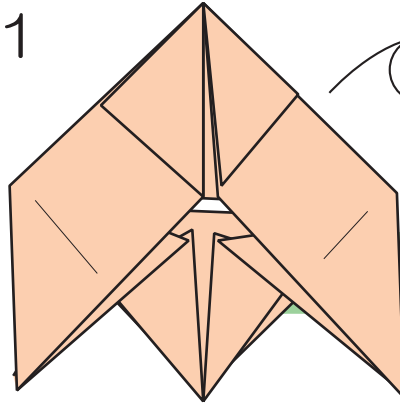

12

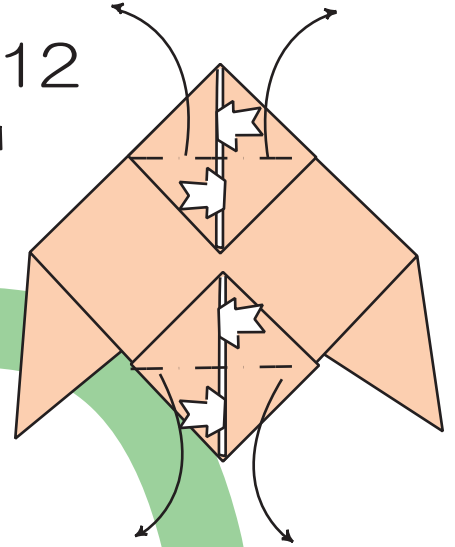

18

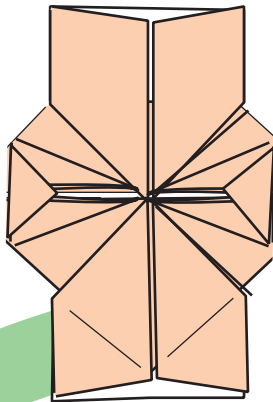

13

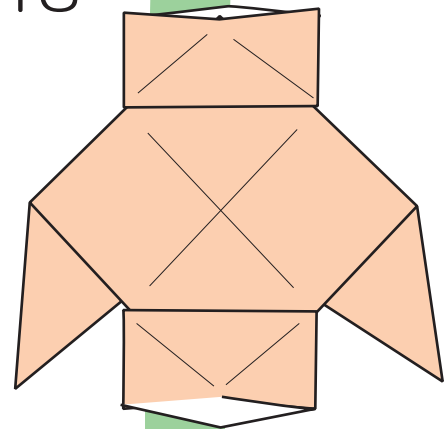

17

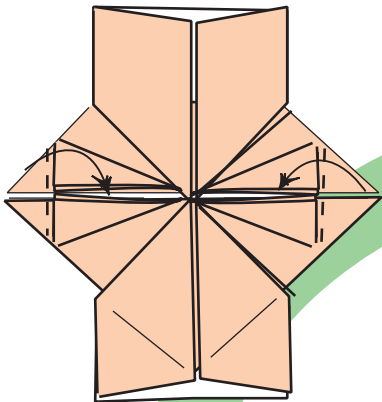

折り線をつけて、折図の16番まで開く。

16

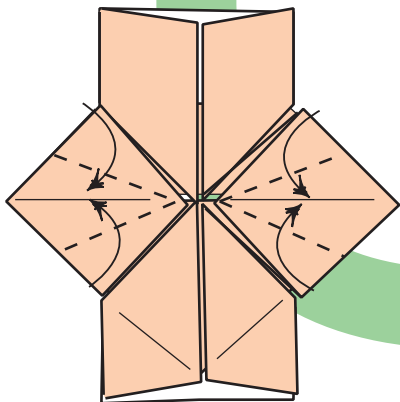

15

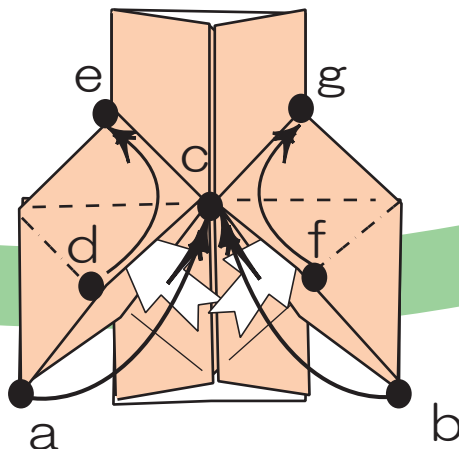

14

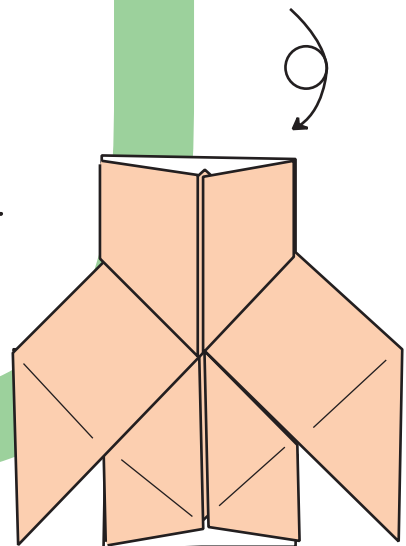

牛のメッセージカード

3/4

Created by Shoko Aoyagi
Diagrams by Shoko Aoyagi

©Shoko Aoyagi 2004

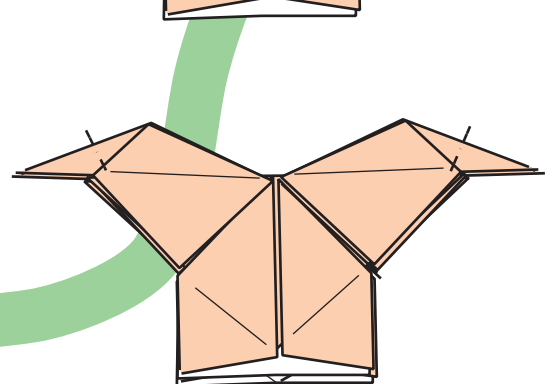
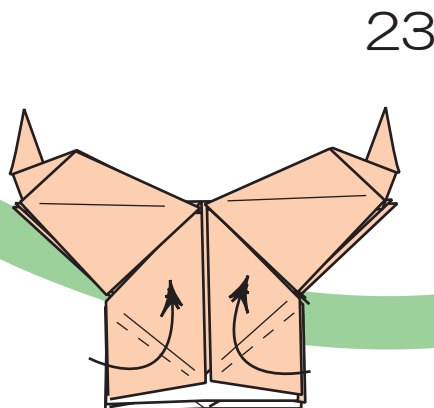
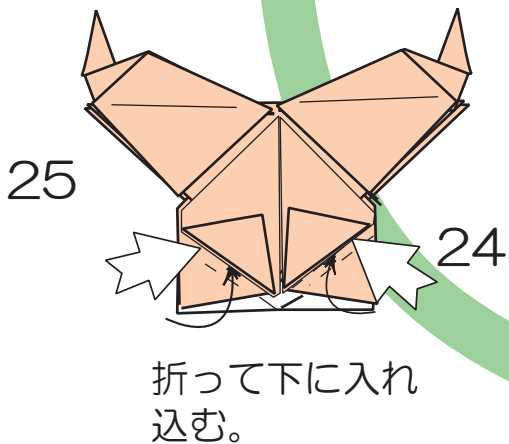
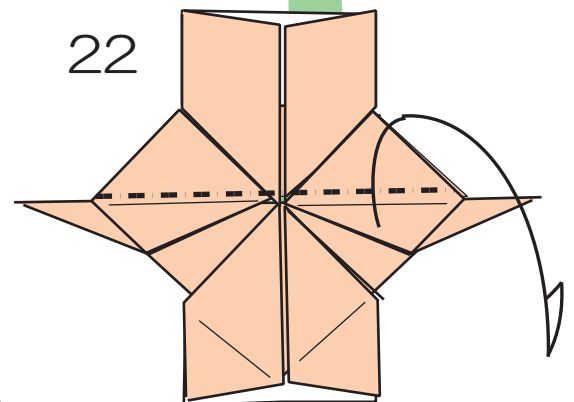
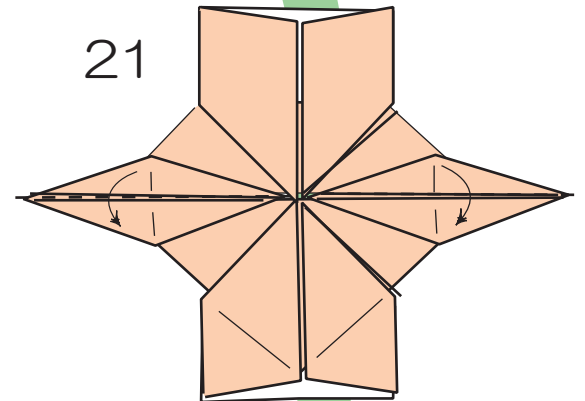
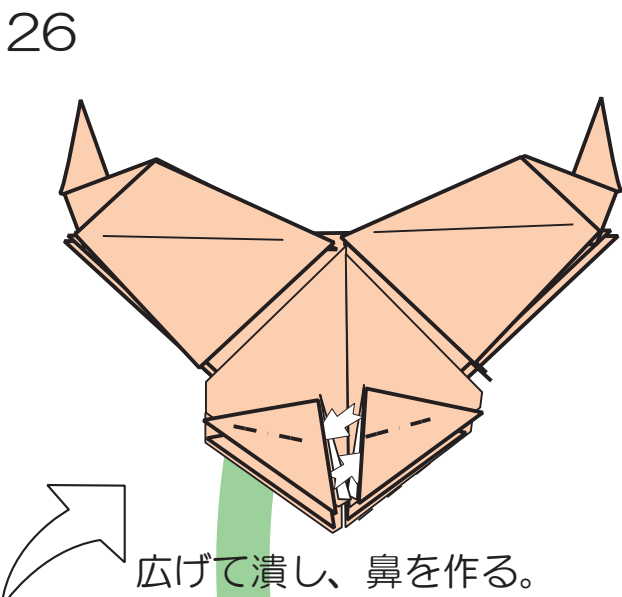
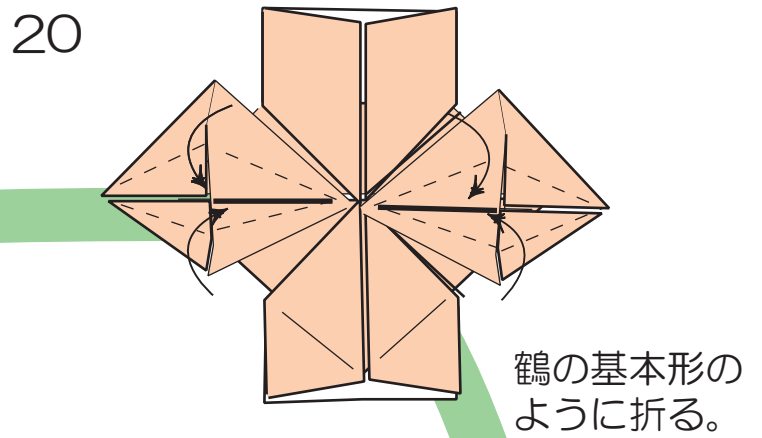
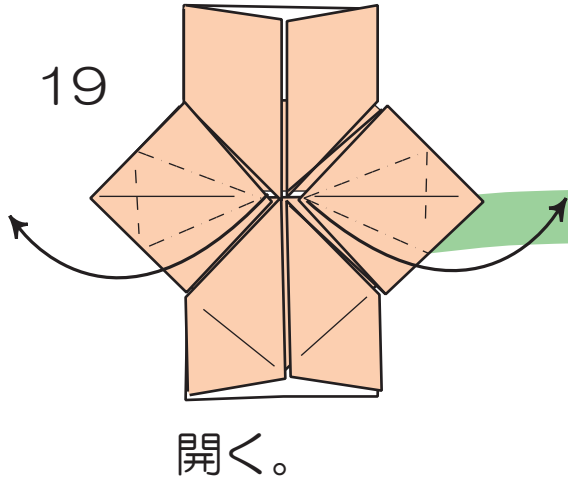
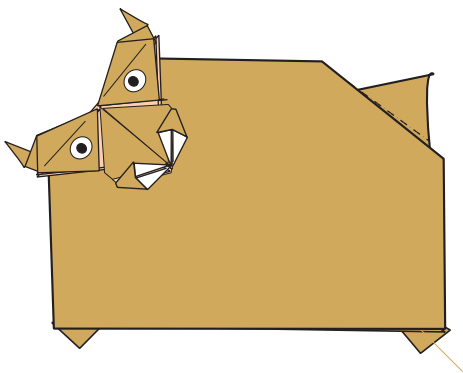

Created by Shoko Aoyagi
Diagrams by Shoko Aoyagi

©Shoko Aoyagi 2004

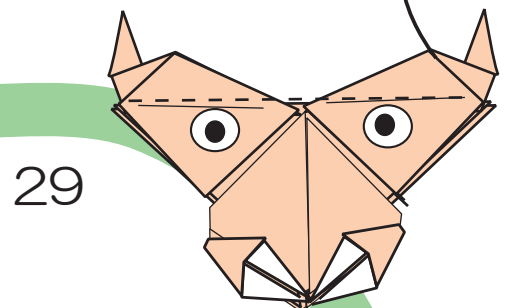
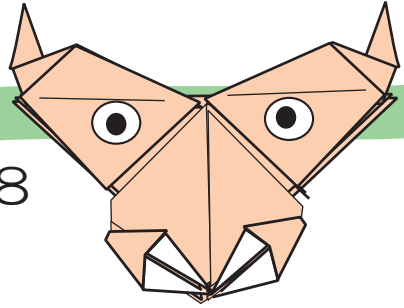
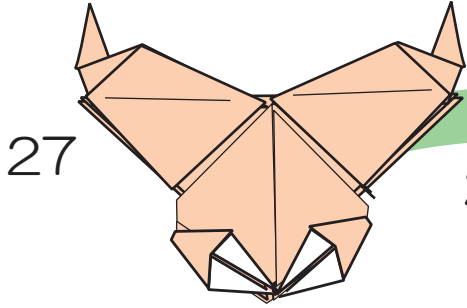
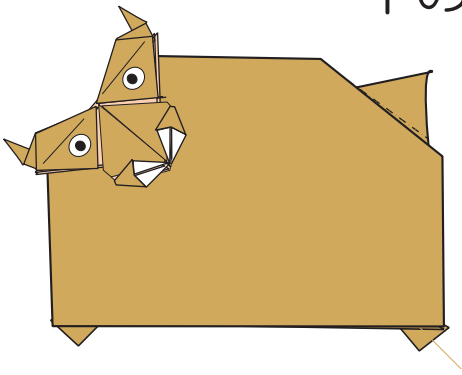

目を描こう！白い丸いシールを貼って、黒目を描いてもいいよ。

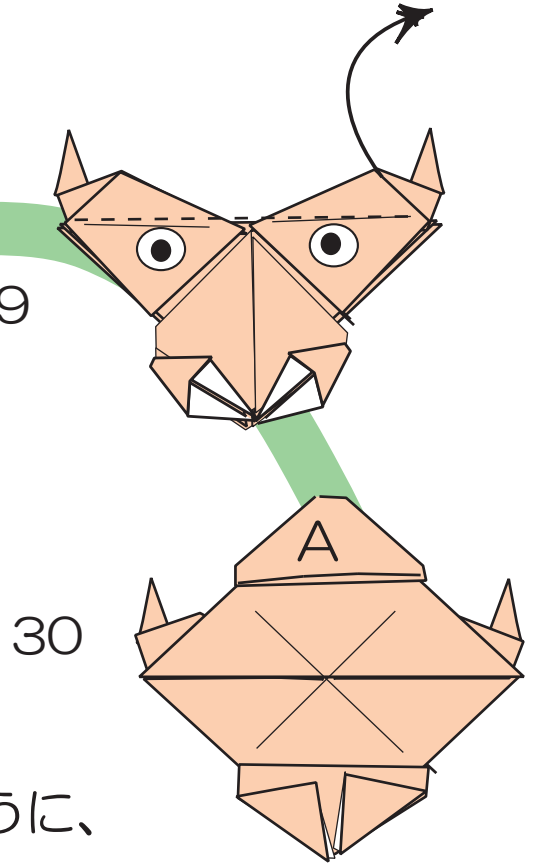

牛に体を図のように、差し込む

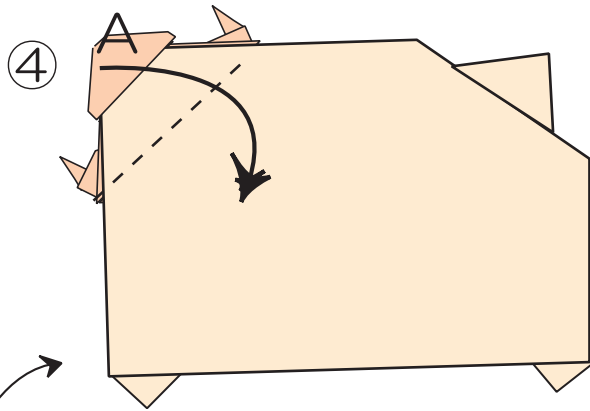
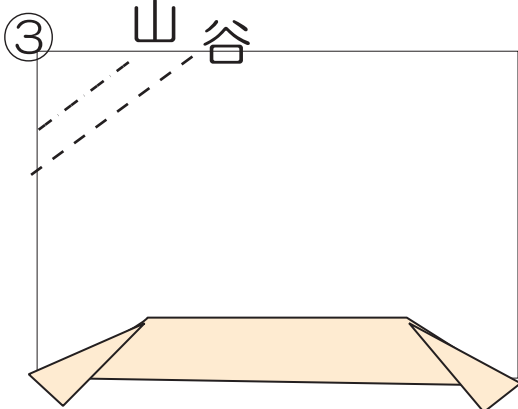
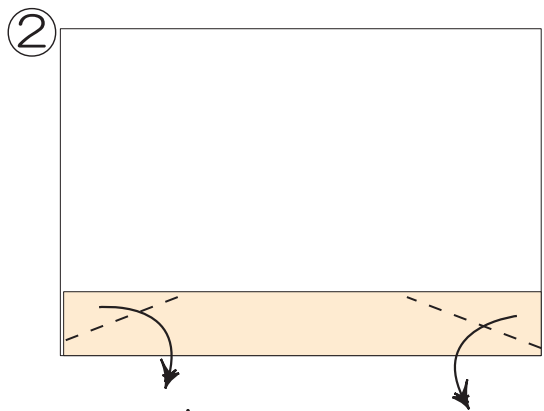
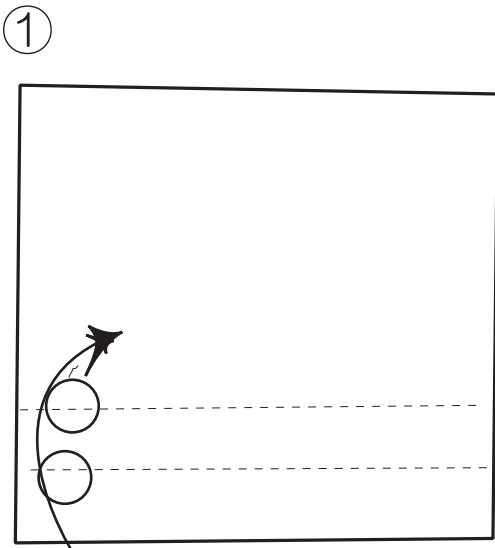

牛の頭はコーナークリップになる

