

プレゼントを運ぶぞうさん

1/5

伝承おりがみ三方とぞうさんの顔を組み合わせ
アレンジ 作品

©Shoko Aoyagi June

グレーのおりがみ用紙 2枚

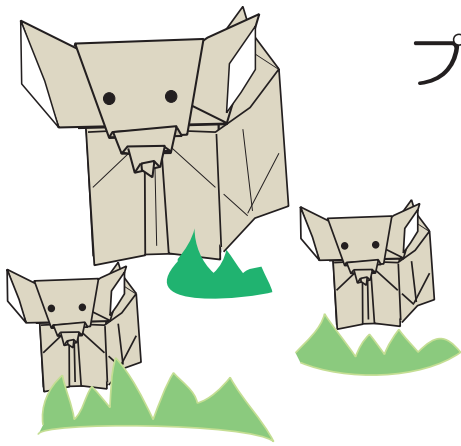

(からだ)

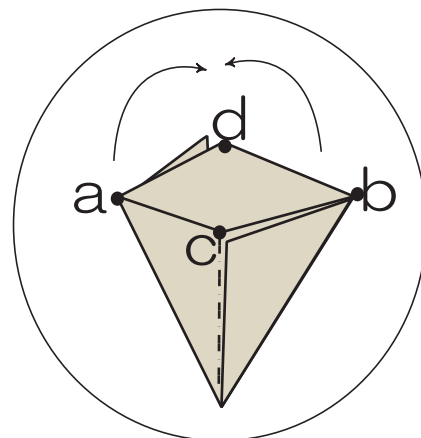
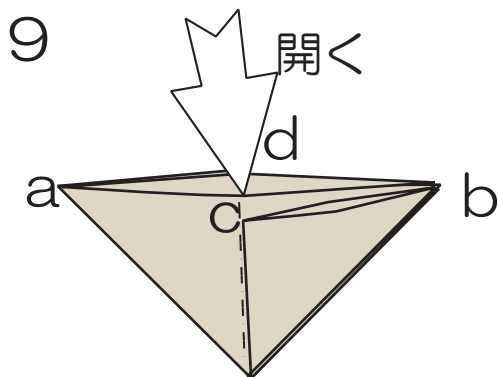
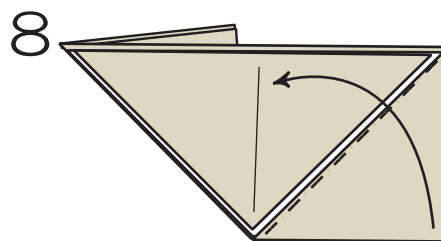
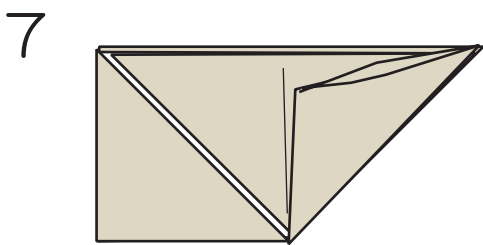
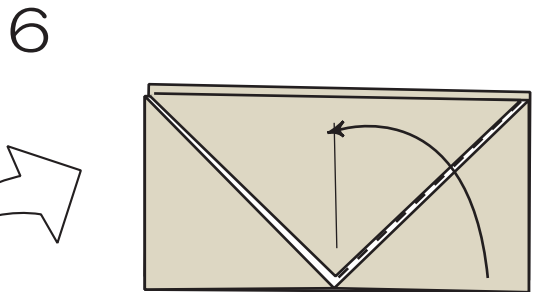
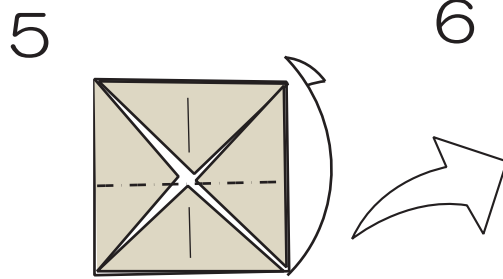
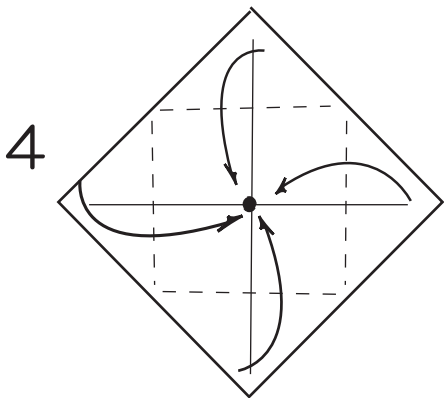
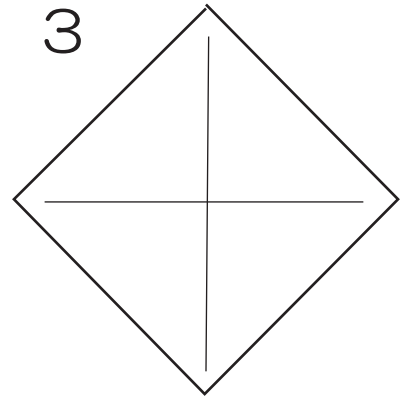
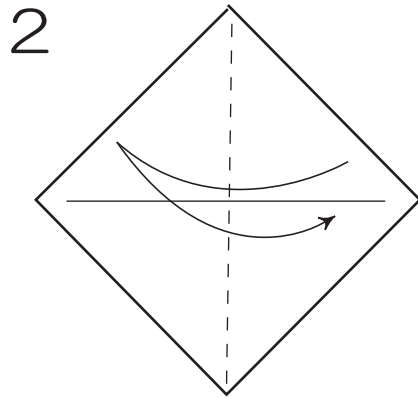
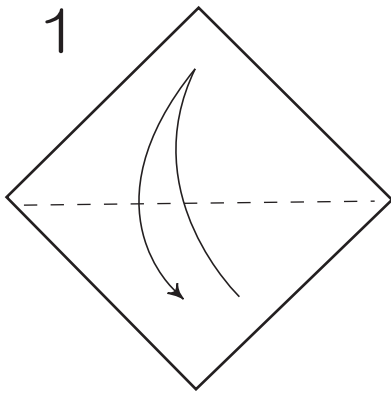

aとbをあわせる

プレゼントを運ぶぞうさん

伝承おりがみ三方とぞうさんの顔を組み合わせ
アレンジ 作品

©Shoko Aoyagi June

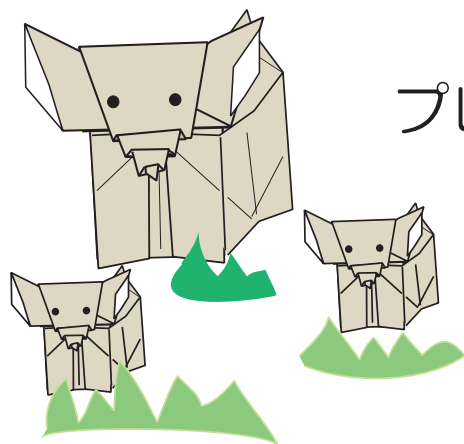

(からだ)

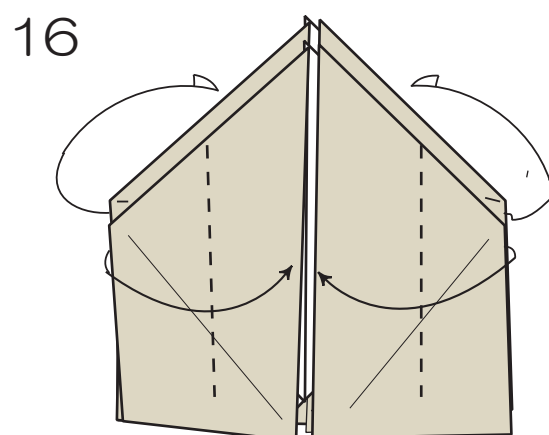
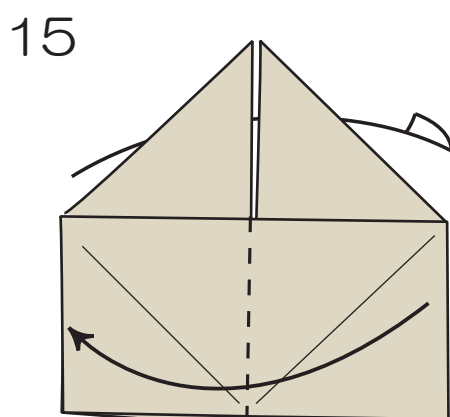
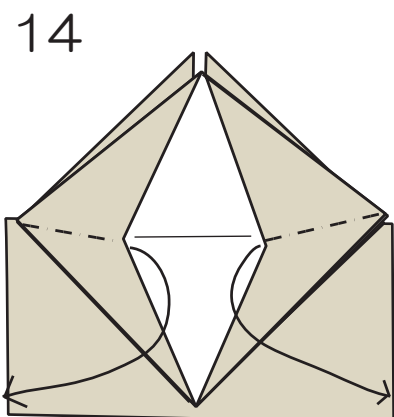
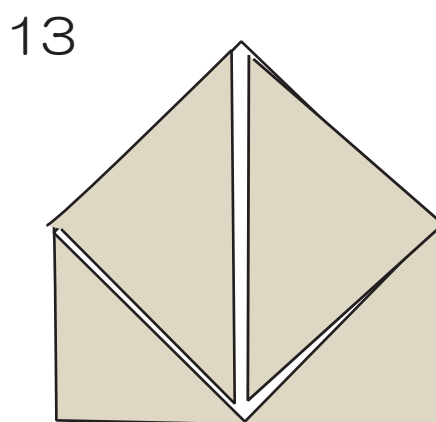
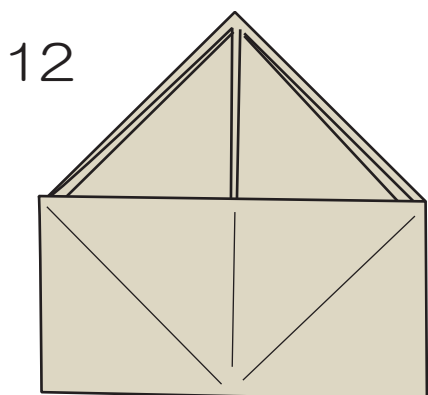
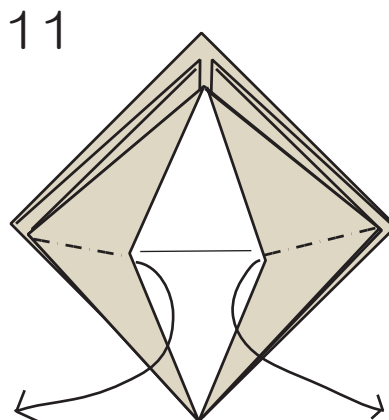
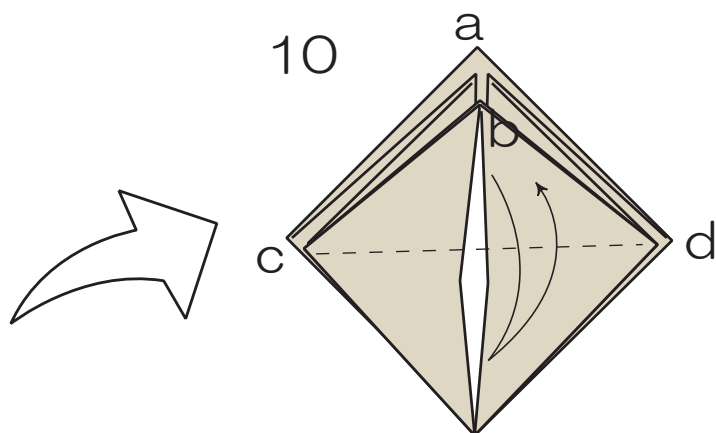

プレゼントを運ぶぞうさん

伝承おりがみ三方とぞうさんの顔を組み合わせ
わアレンジ 作品

©Shoko Aoyagi June

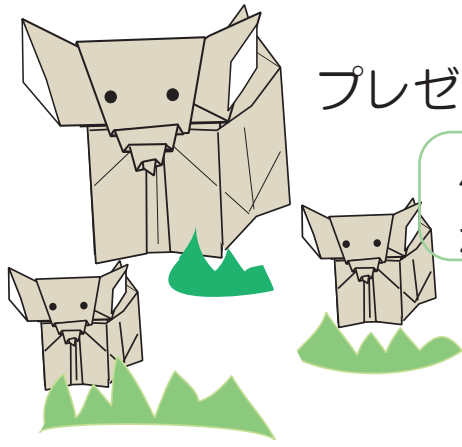

(からだ)

17

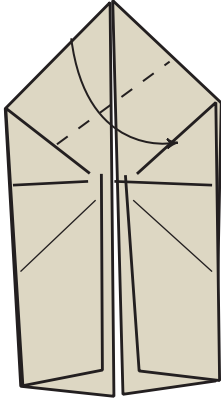

18

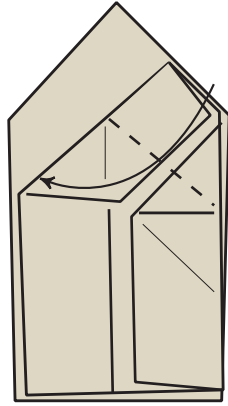

19

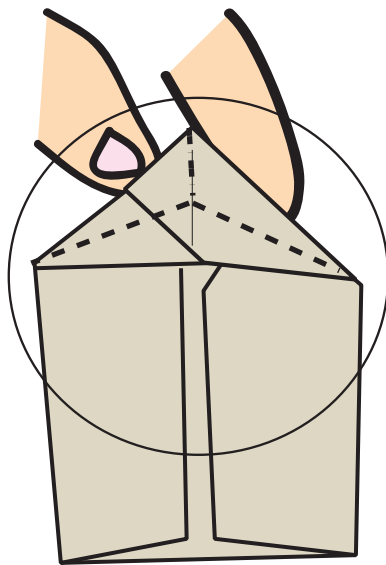
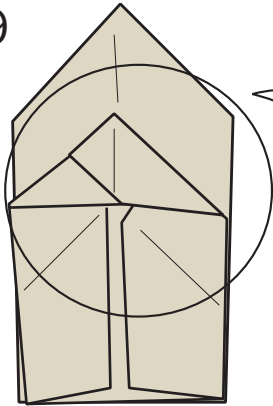

しっぽ

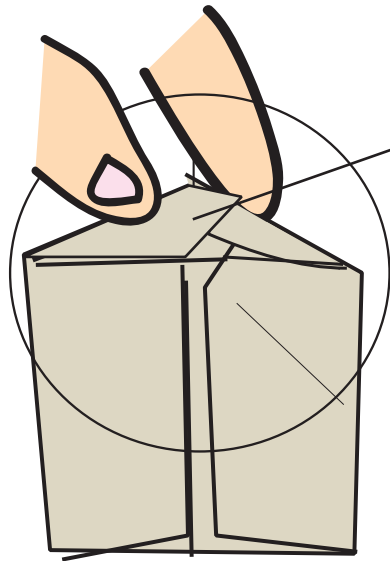

20

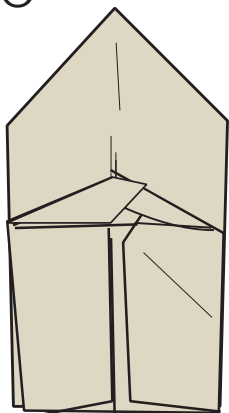

21

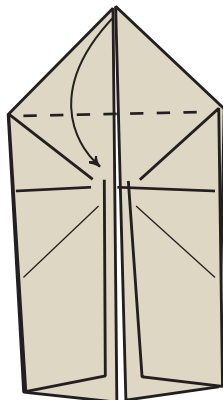

22

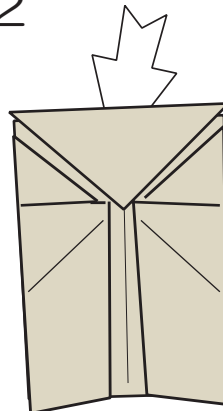

開いて立体に
23 する。

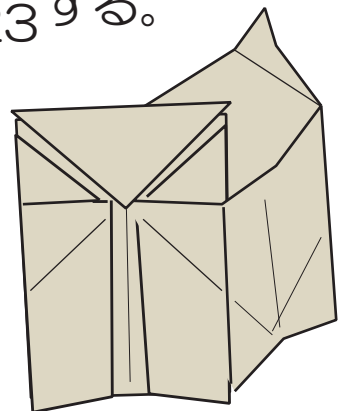

からだが出来ました。

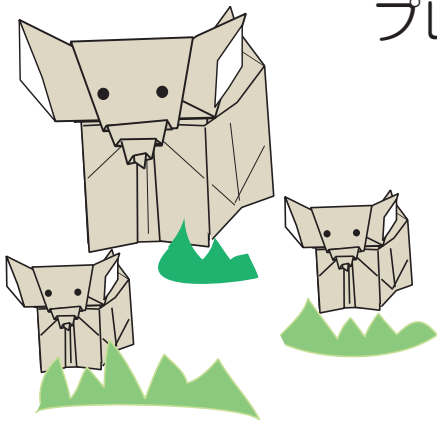

伝承おりがみ三方とぞうさんの顔を組み合わせアレンジ 作品

©Shoko Aoyagi June

(あたま)

1

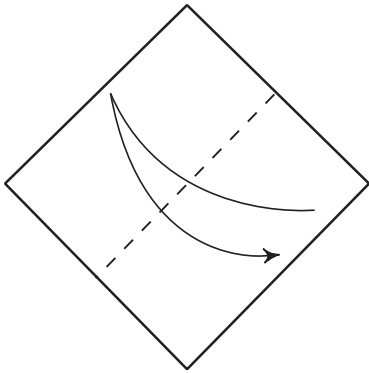

2

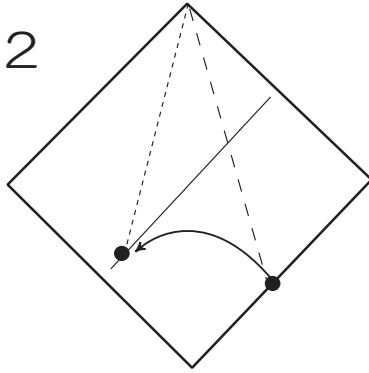

3

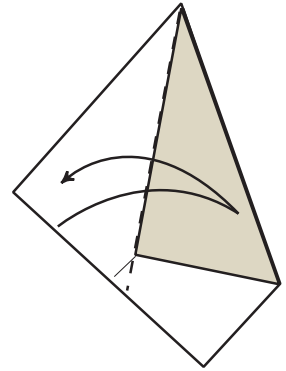

4

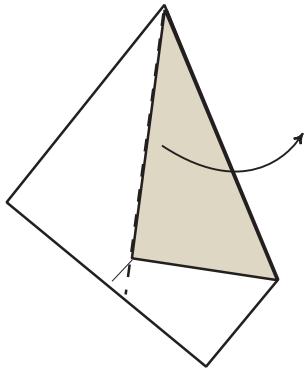

5

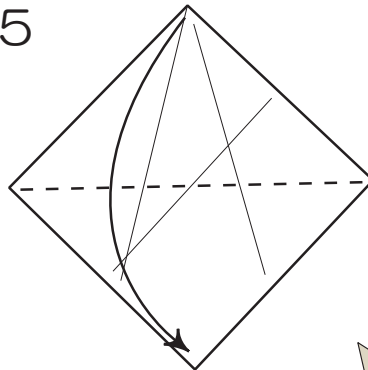

6

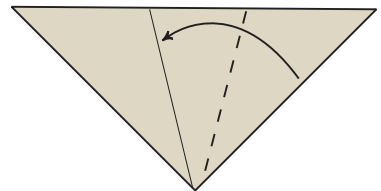

7

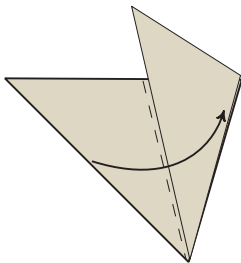

8

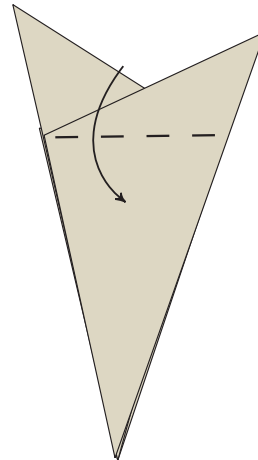

9

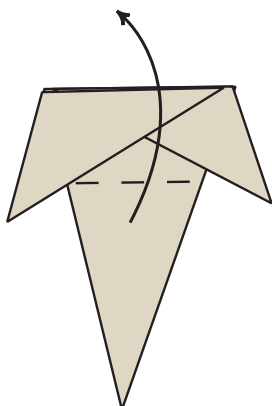

10

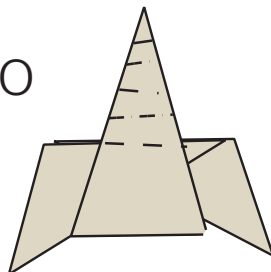

11

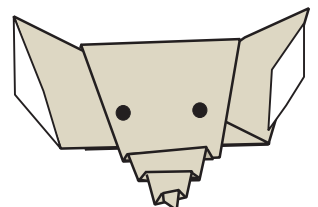

あたまの出来上がり

伝承おりがみ三方をアレンジ

©Shoko Aoyagi June

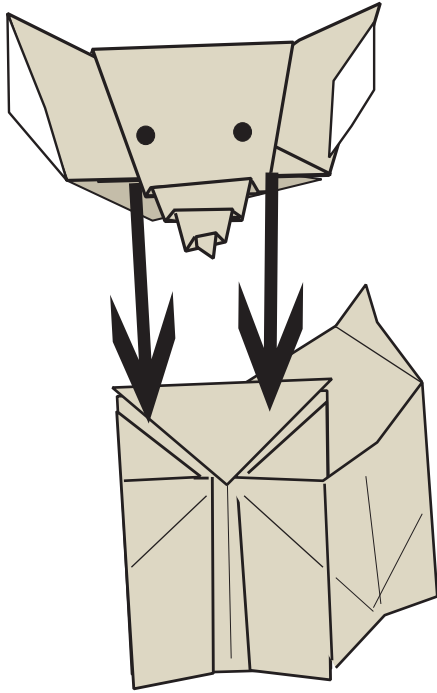

あたまをからだに差し込んでくっつけましょう。
少し糊をつけると、外れません。

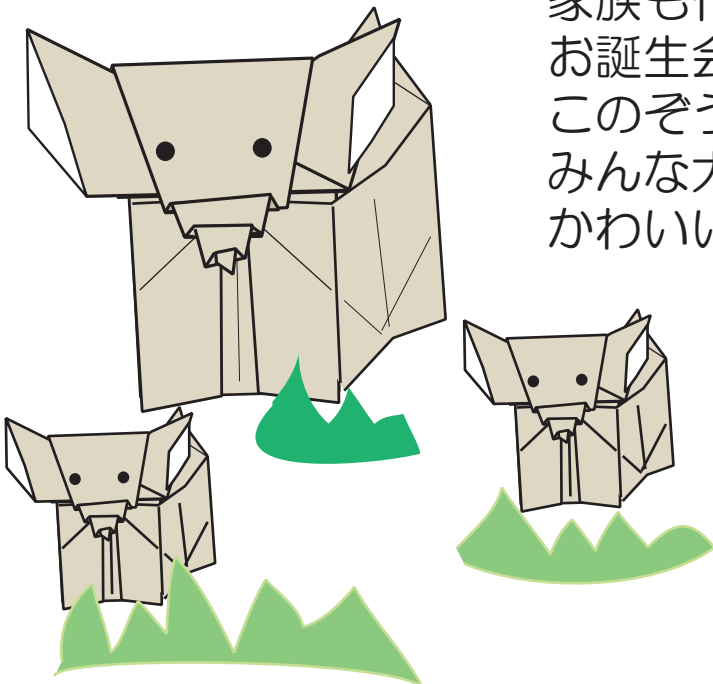

家族も作って楽しみましょう。
お誕生会やパーティのお土産のお菓子を
このぞうさんに入れて配ったら
みんな大喜び！！
かわいいから作ってみてね。