

# Sleeping Cat

Created by Shoko Aoyagi  
Diagrams by Shoko Aoyagi

© Shoko Aoyagi March 2009

You need 2 sheets of origami paper the same size.

(Head of the cat)

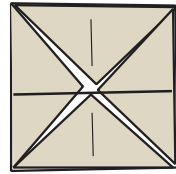

Start with a blintz base.

1

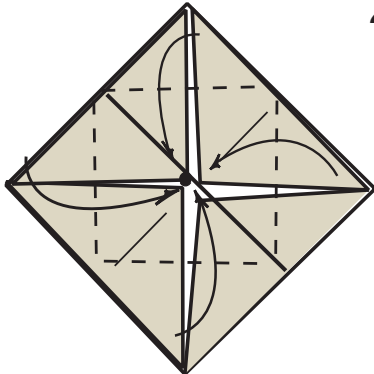

2

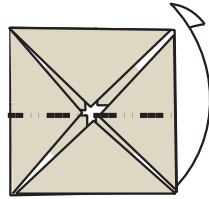

3

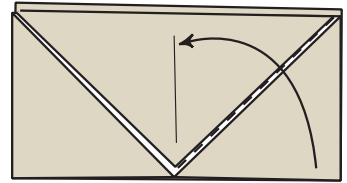

4

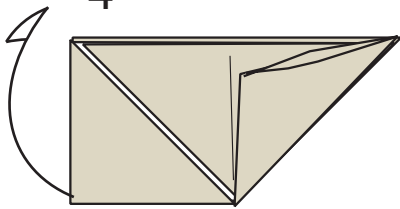

5

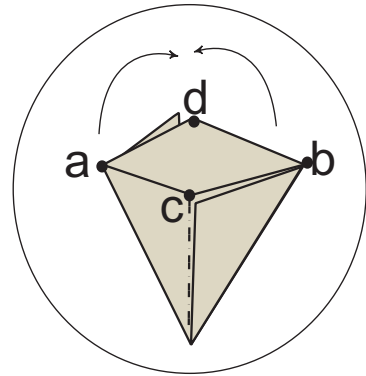
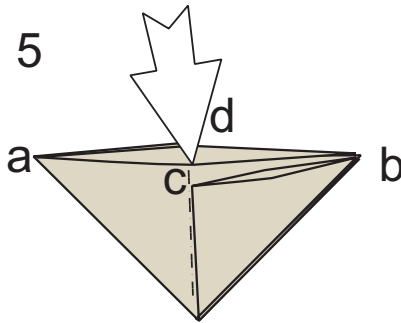

6

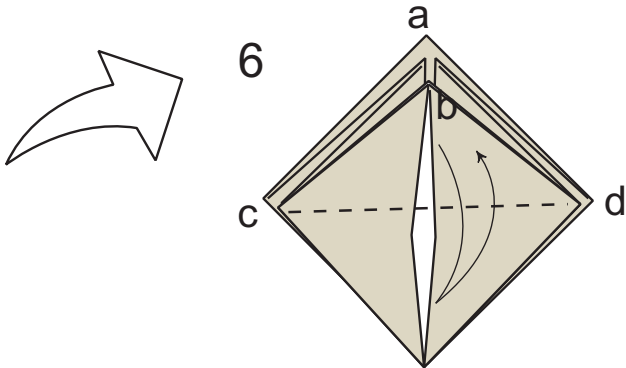

7

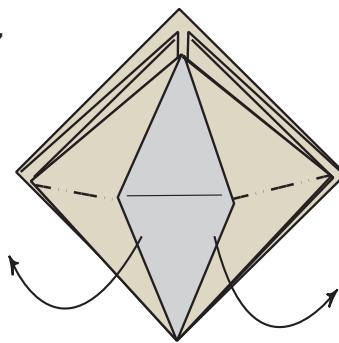

8

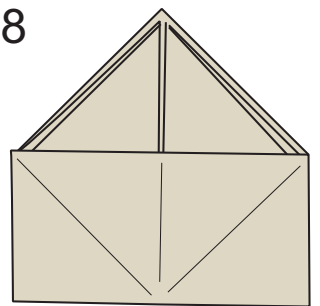

9

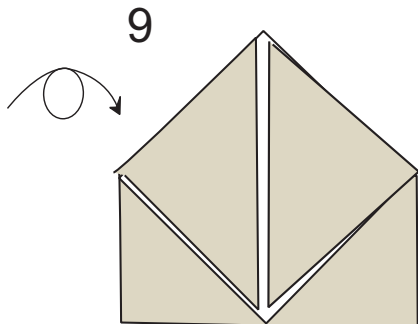

10

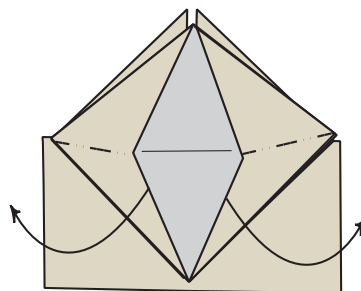

11

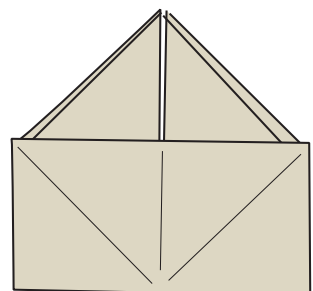

# Sleeping cat

Created by Shoko Aoyagi  
Diagrams by Shoko Aoyagi

© Shoko Aoyagi March 2009

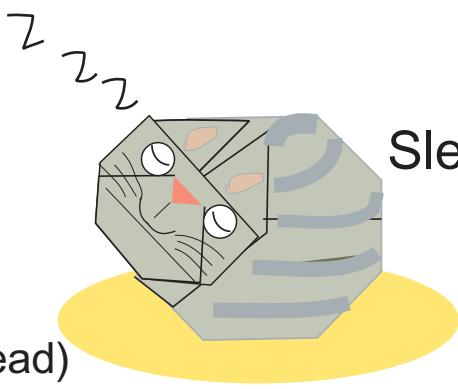

(Head)

11

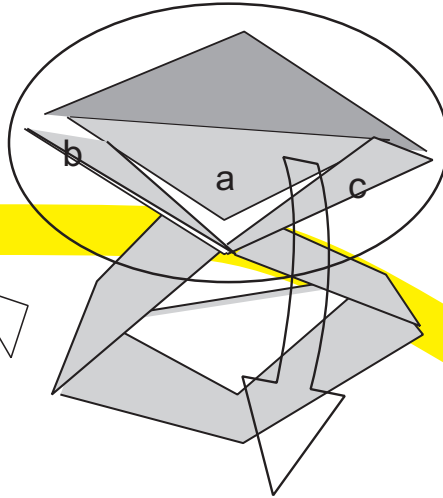
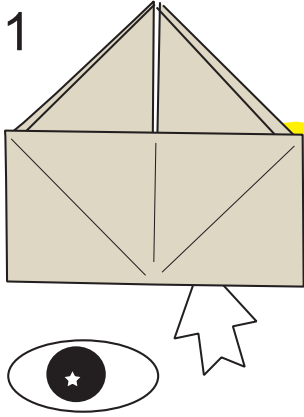

12

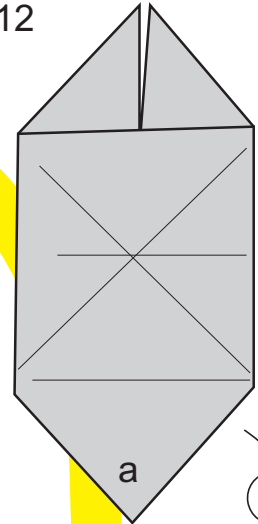

Carefully pull out the loose flap 'a' so that points 'b' and 'c' don't tear.

13

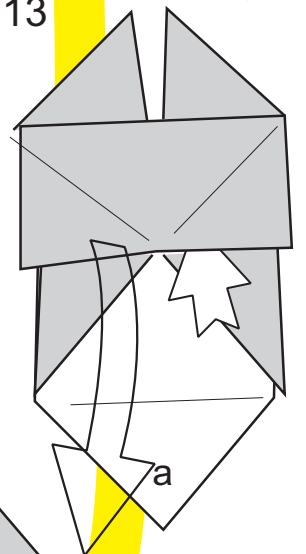

Repeat on the other side.

18

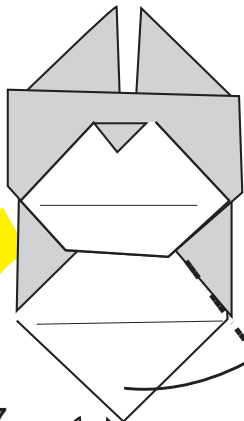

19

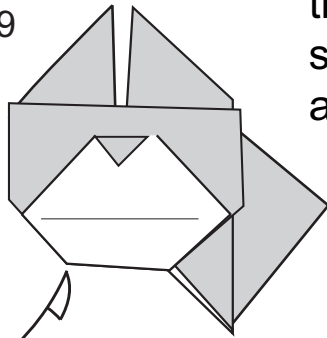

Attach round stickers for eyes and draw eyeballs. Your cat's cute face is done.

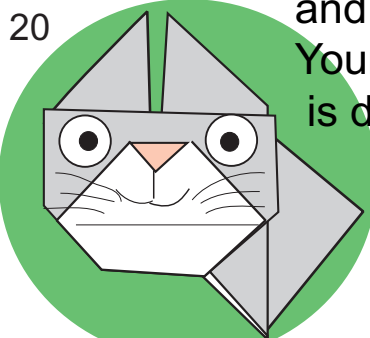

20

Add a mouth and whiskers.

17

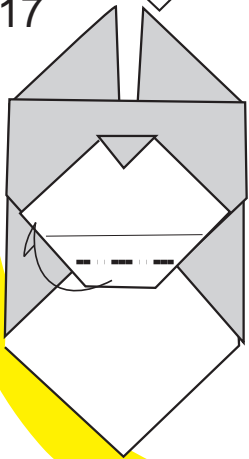

16

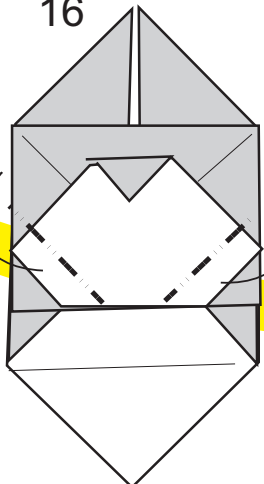

15

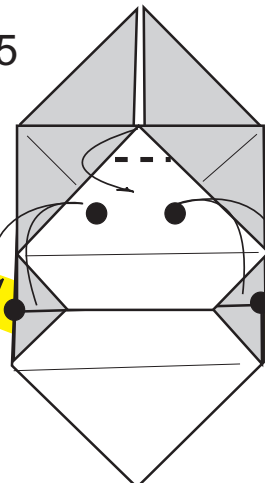

14

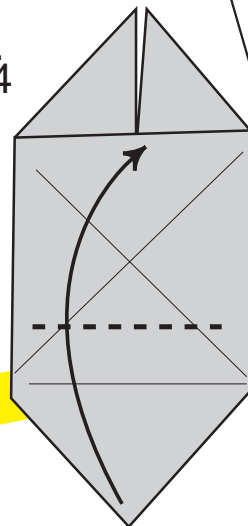

Fold back using the existing crease lines.

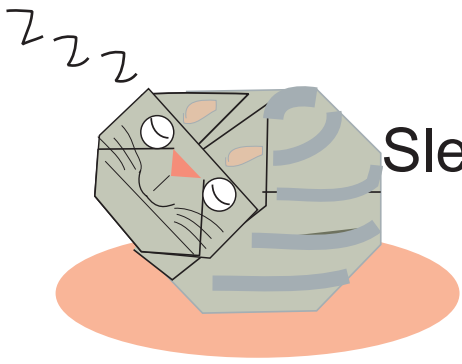

# Sleeping cat

Created by Shoko Aoyagi 3/3  
Diagrams by Shoko Aoyagi

© Shoko Aoyagi March 2009

(Round body)

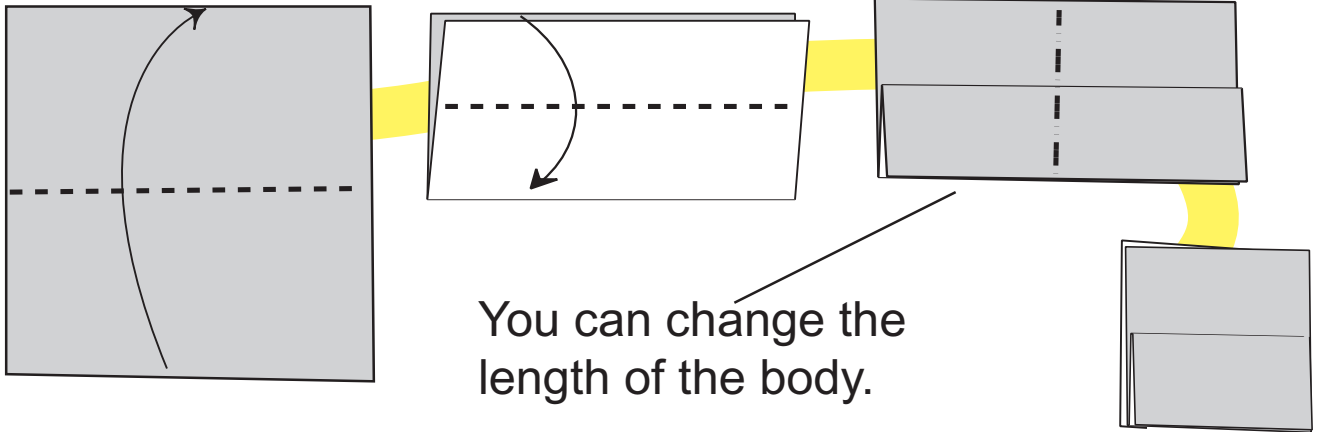

Here is the body of the cat.

Assemble the cat.

