

Kangaroo with pouch

1/5

© Shoko Aoyagi 2002

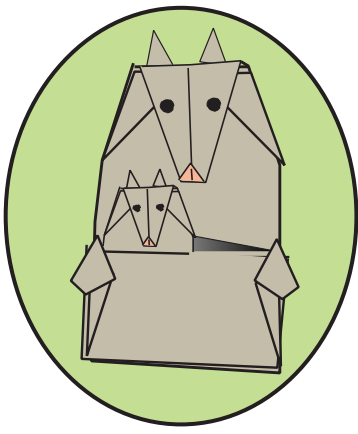

You need a sheet of A4 copy paper.

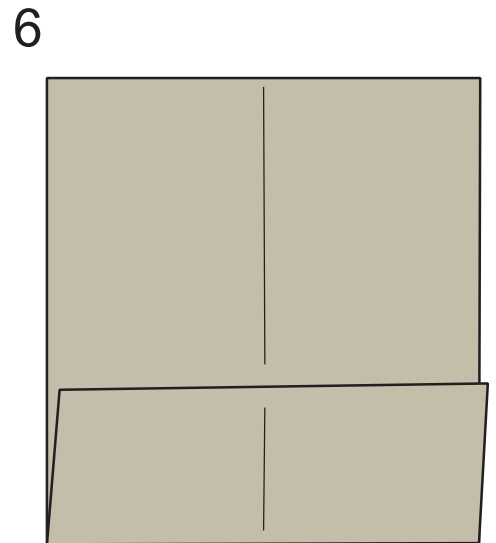
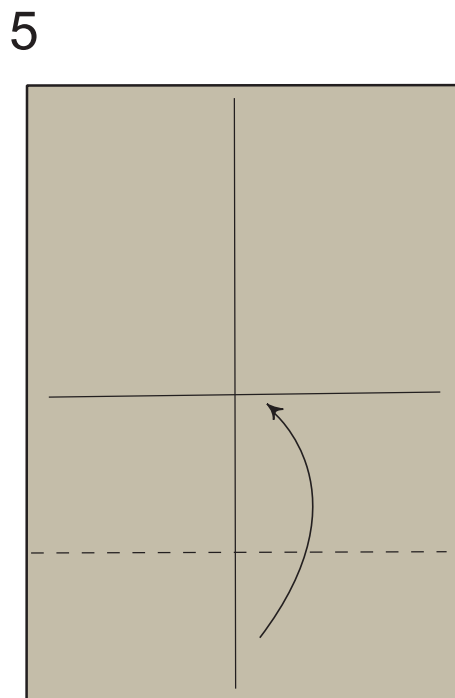
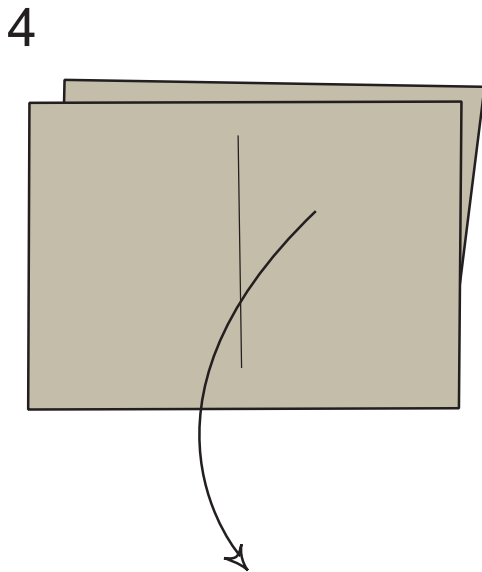
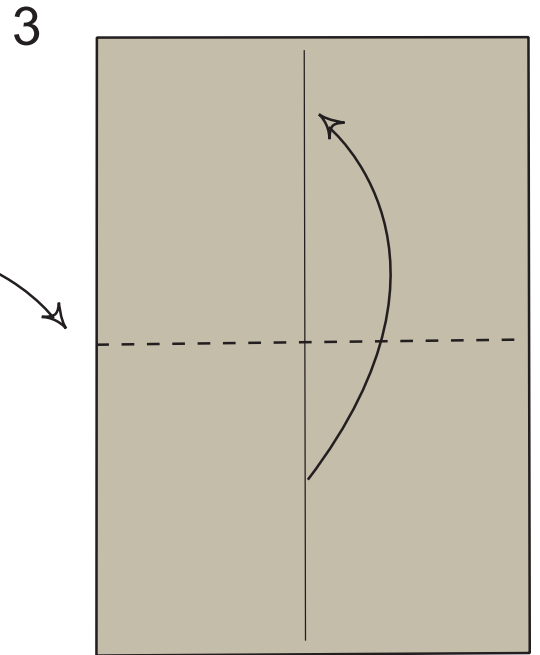
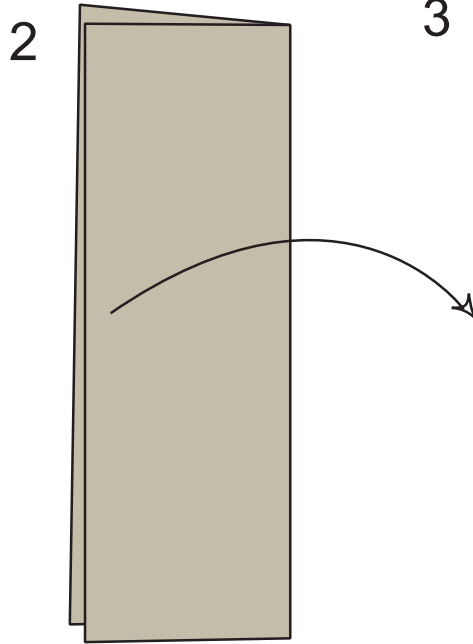
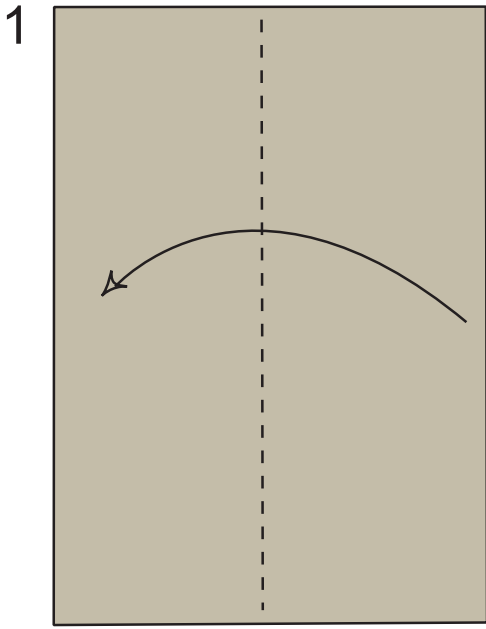

Kangaroo with pouch

2/5

© Shoko Aoyagi 2002

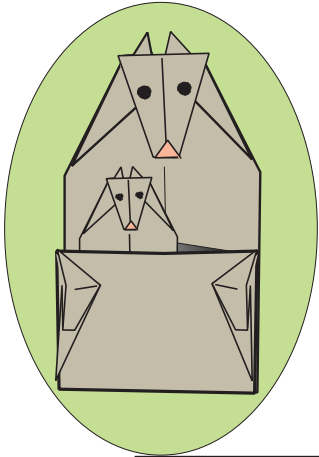

7

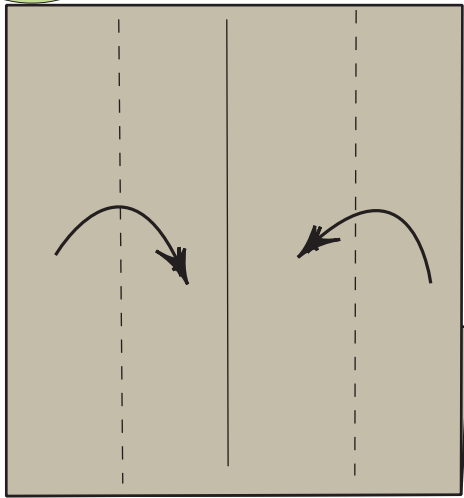

8

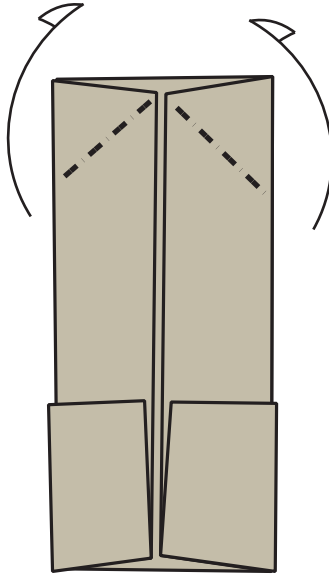

9

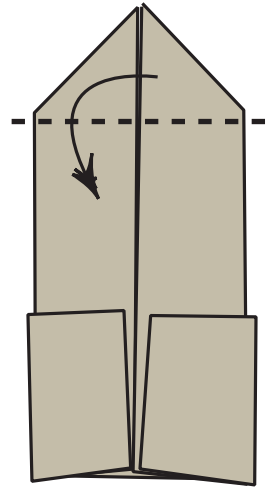

Fold towards you.

Fold away from you

10

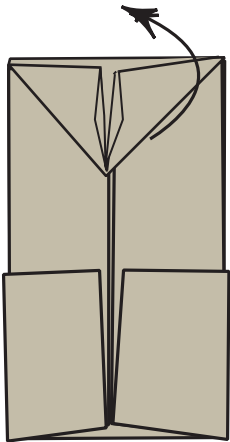

Unfold

11

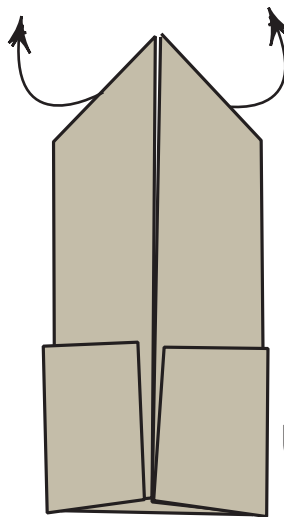

Unfold

12

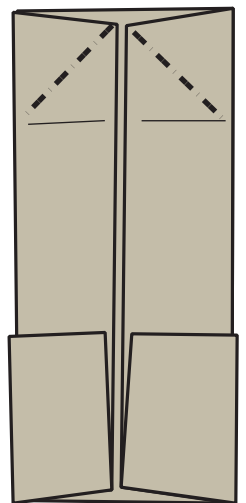

13

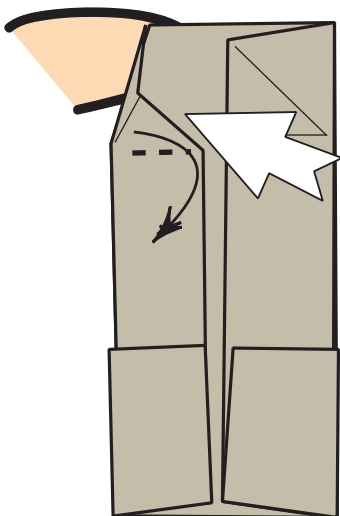

Open the left top flap and squash fold as shown.

14

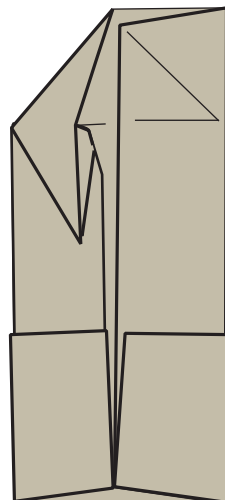

This is the result.
Repeat with the
other side.

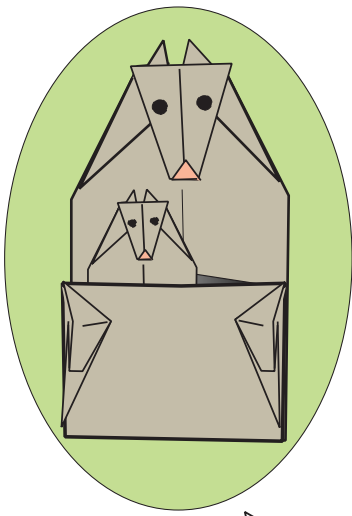

15

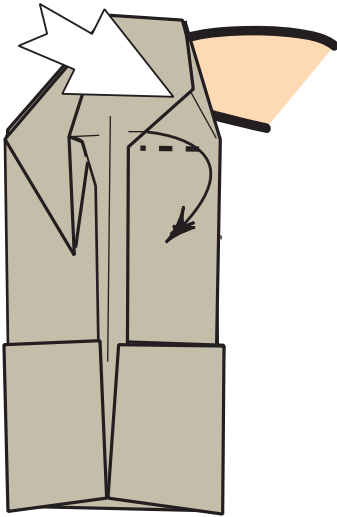

Open the right top flap and squash fold as shown.

16

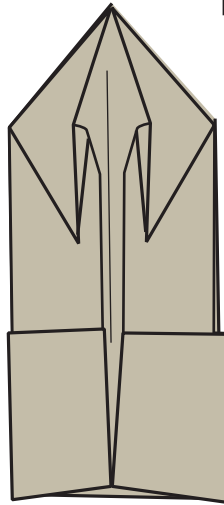

17

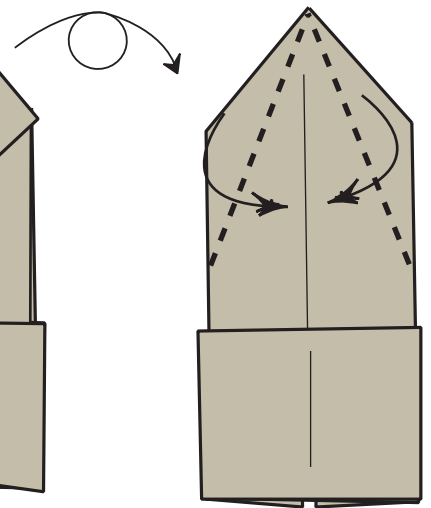

This is the result.

18

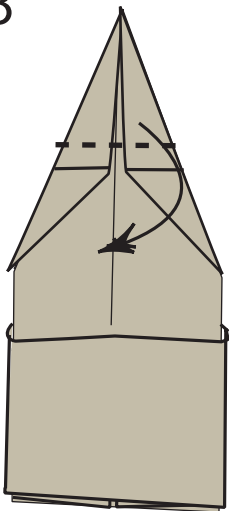

enlarged view

19

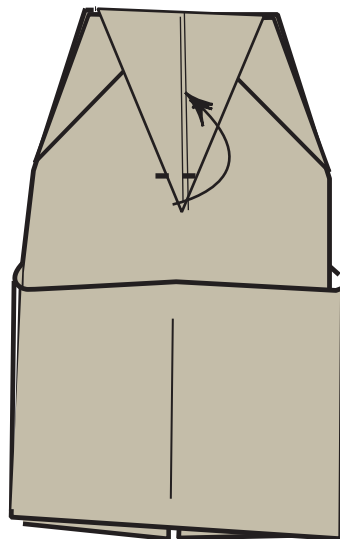

20

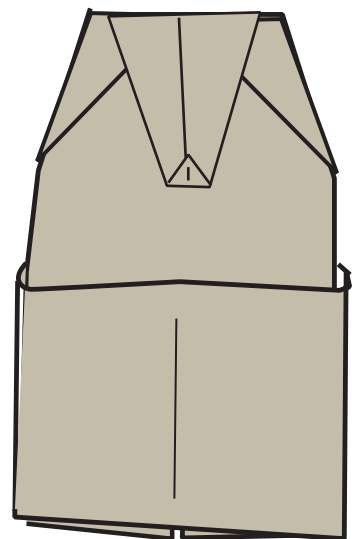

Kangaroo with pouch

© Shoko Aoyagi 2002

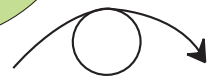
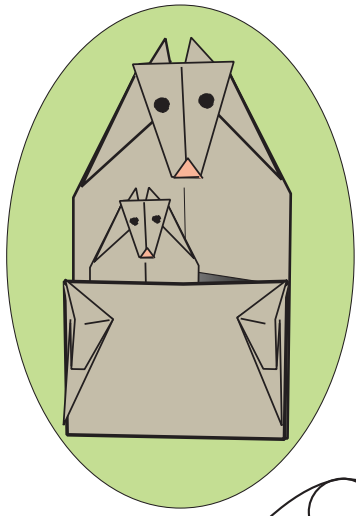

Turn it over.

21

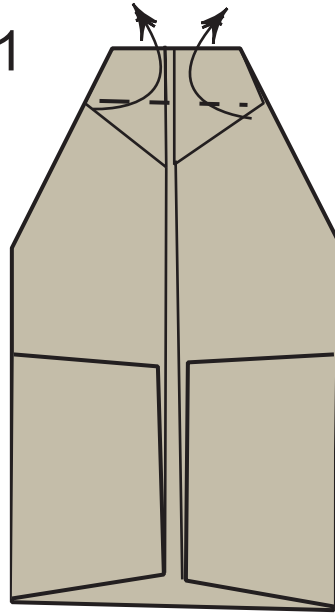

22

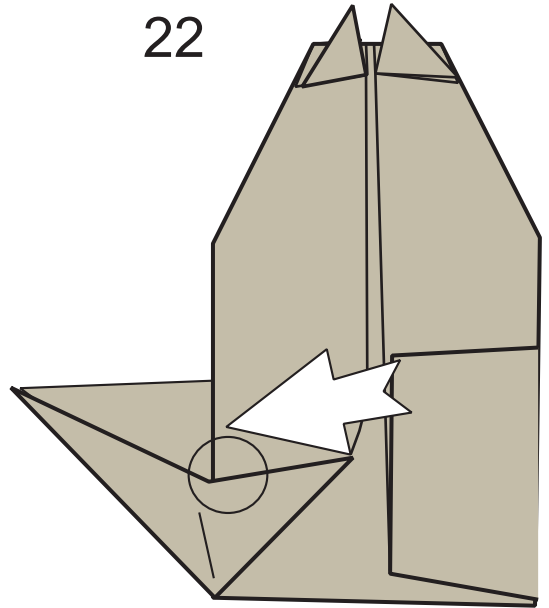

Open the left top flap and squash fold as shown. Repeat with the other side.

23

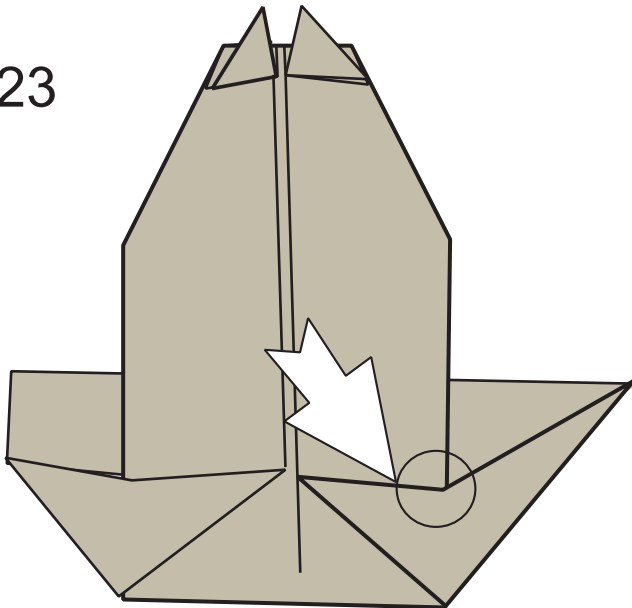

24

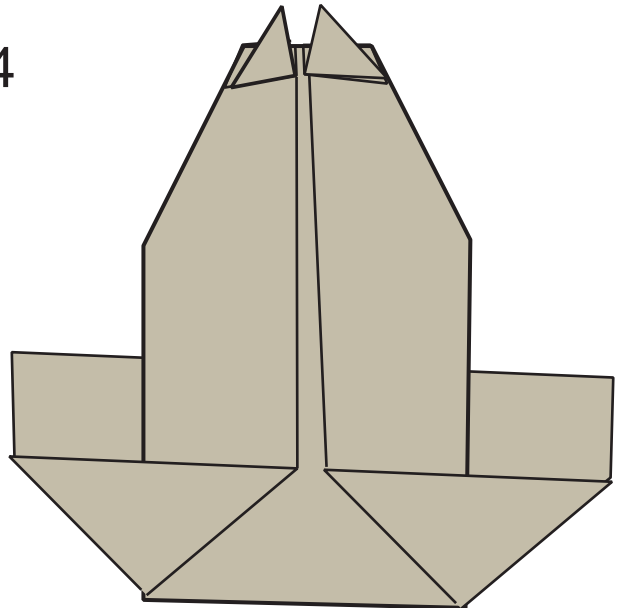

25

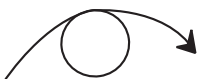

Turn it over.

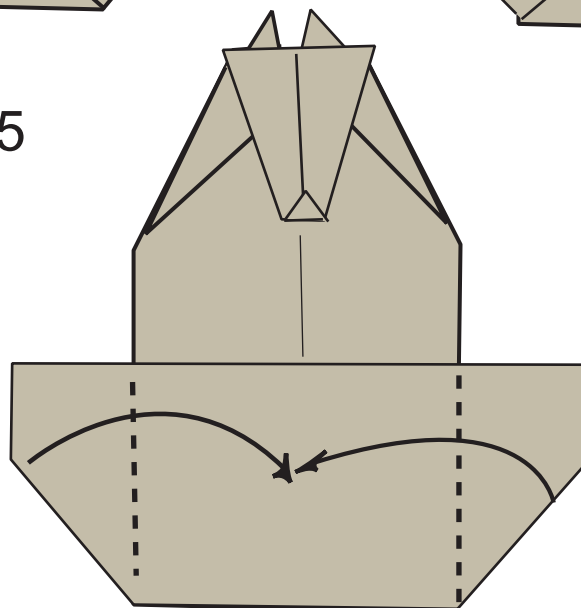

Kangaroo with pouch

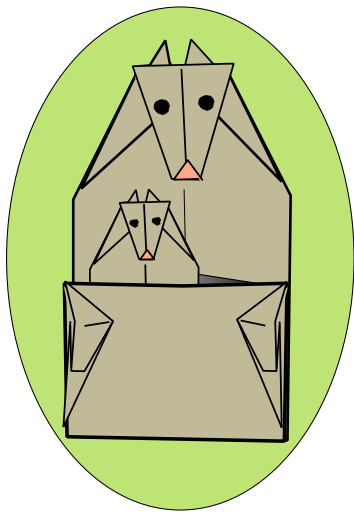

26

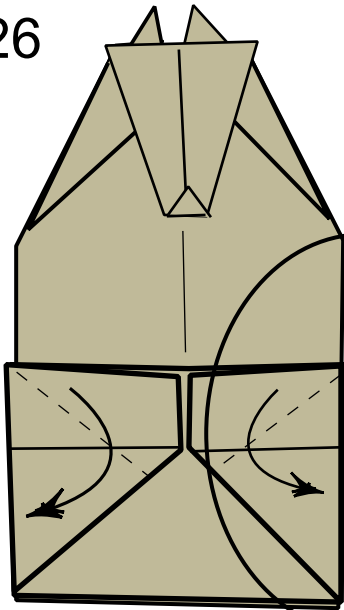

Make 'Rabbit Ear fold' to make its paws.
See diagrams 1-7.
Repeat with the other side.

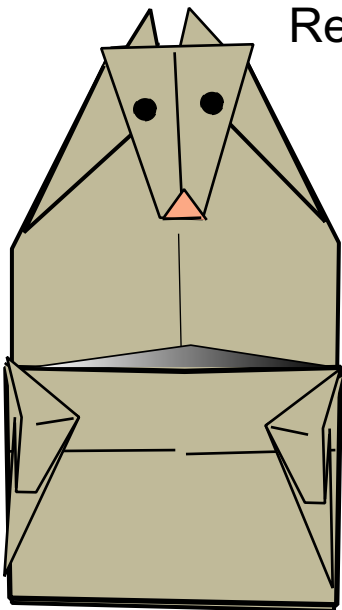

Here is a kangaroo with its pouch.

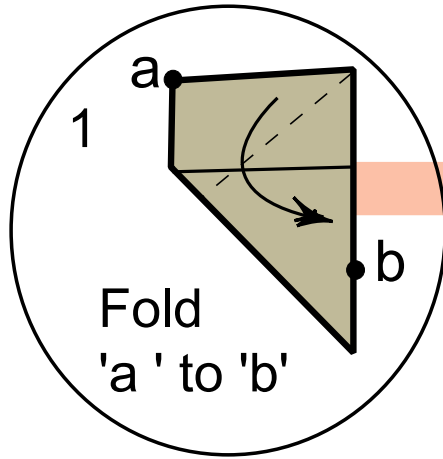

Fold 'a' to 'b'

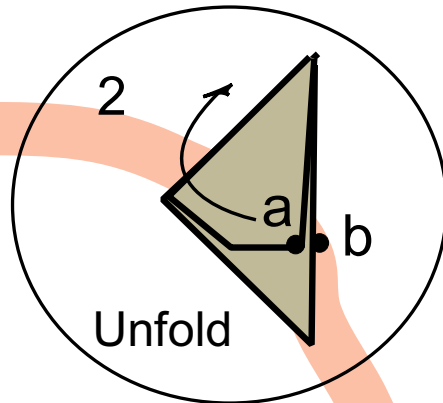

Unfold

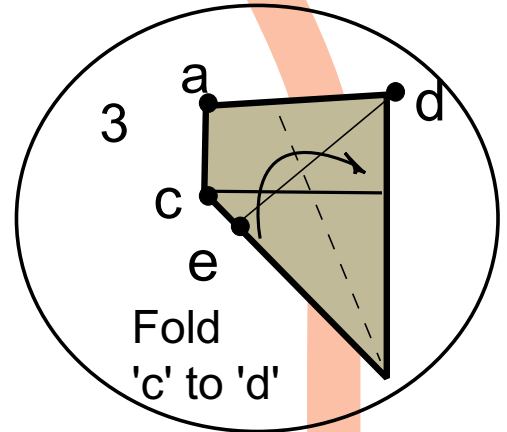

Fold 'c' to 'd'

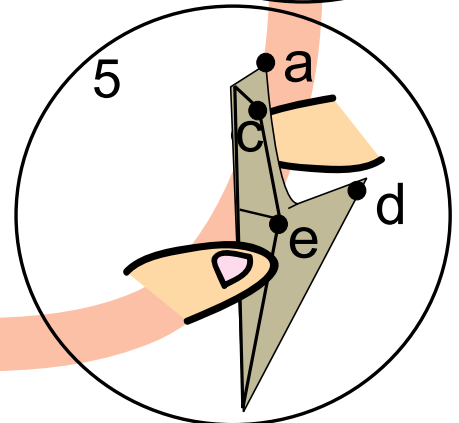
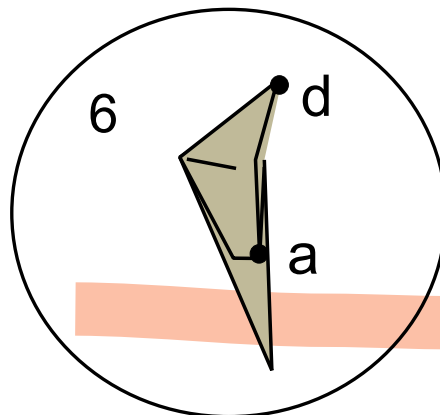
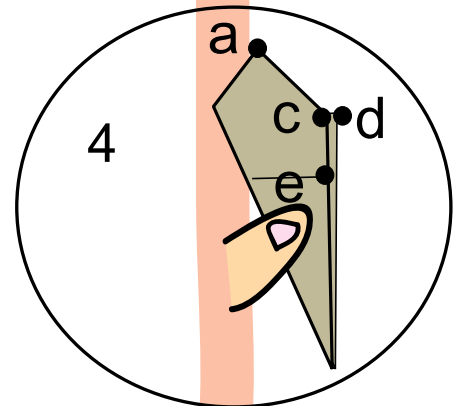

Press under the 'e' steady with your left index finger, bring down the top flap as shown. See the diagram 6.