

Hopping-mouse

© Shoko Aoyagi 2004

You need a sheet of origami paper.

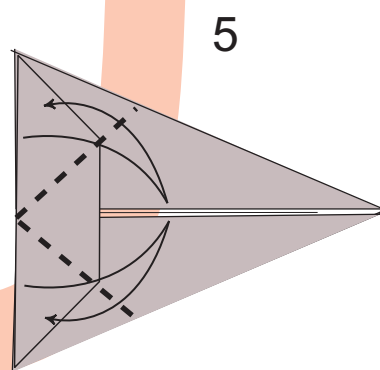
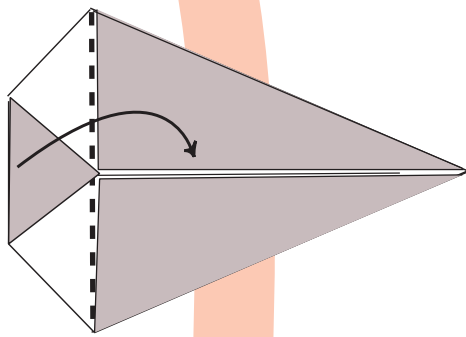
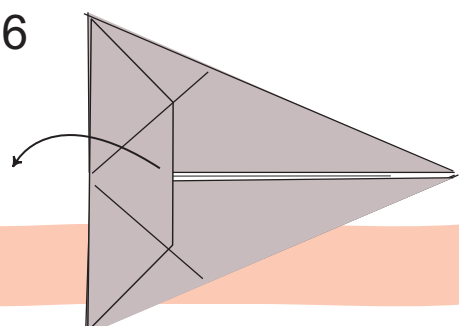
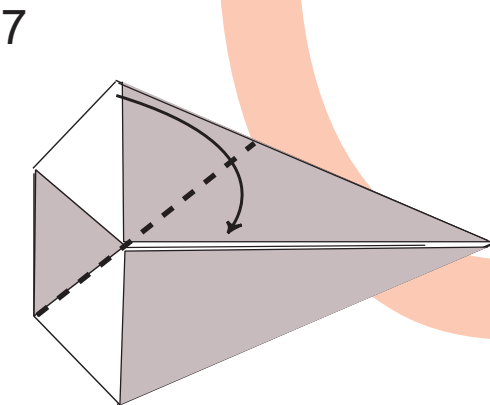
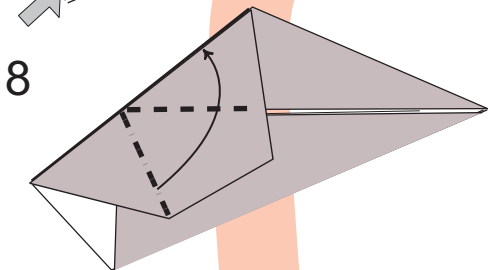
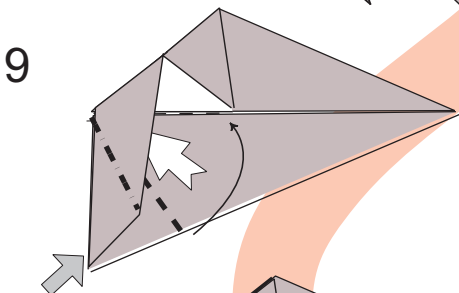
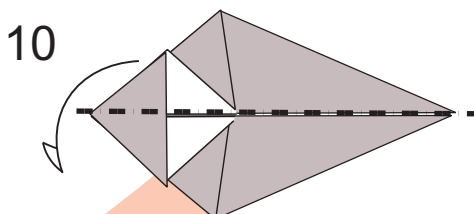
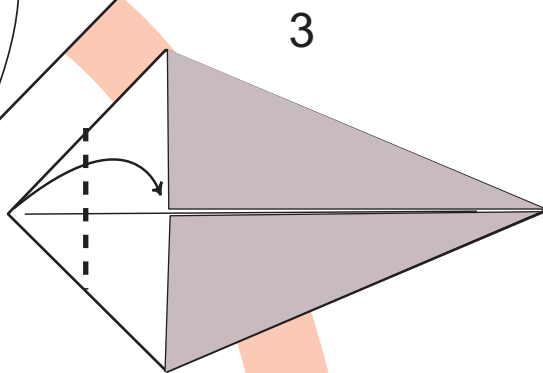
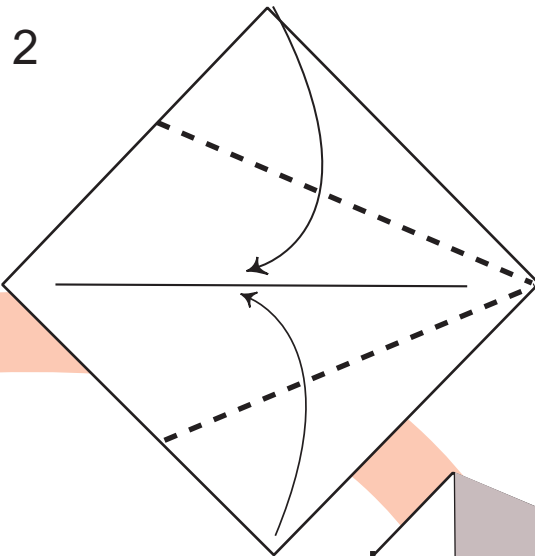
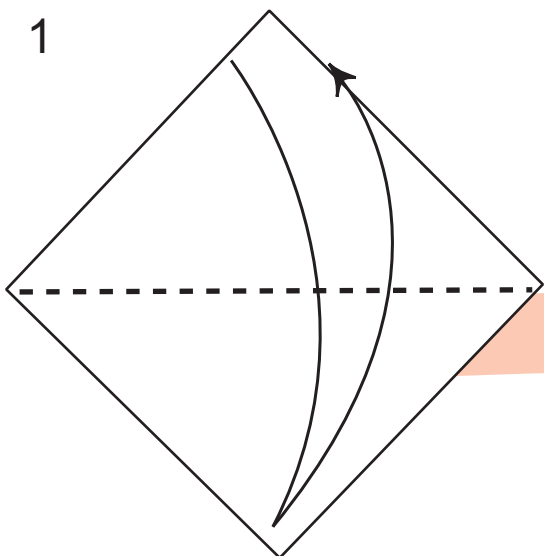
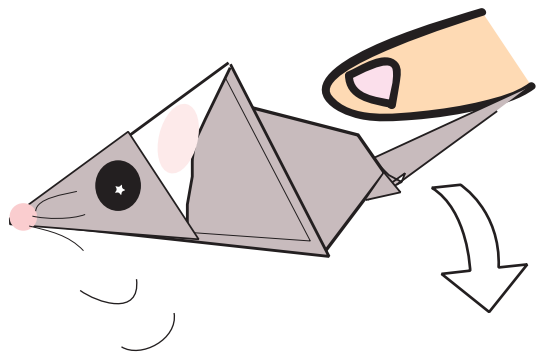

Unfold

Crease well and unfold.

Hopping-mouse

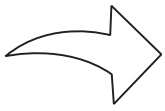
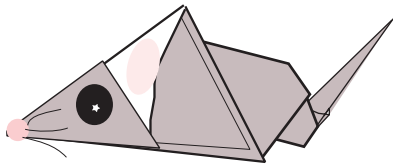

11

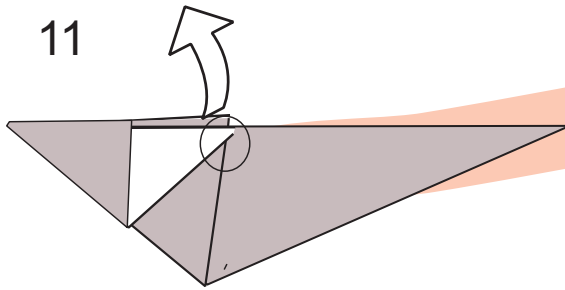

12

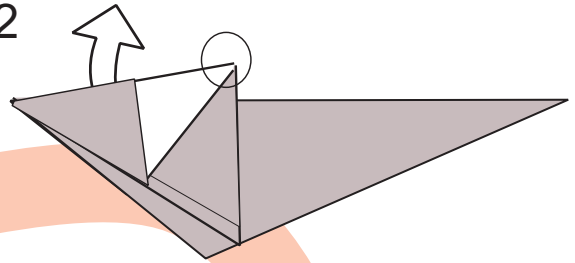

Repeat on the other side.

13

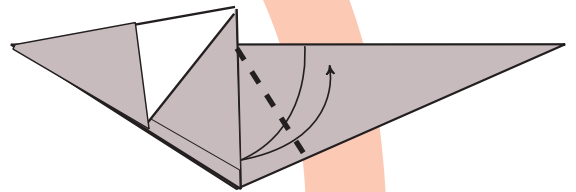

14

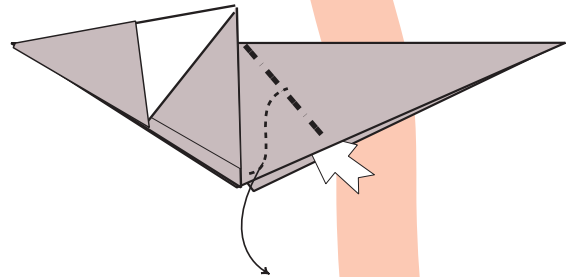

15

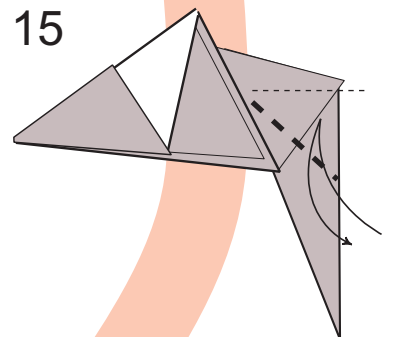

16

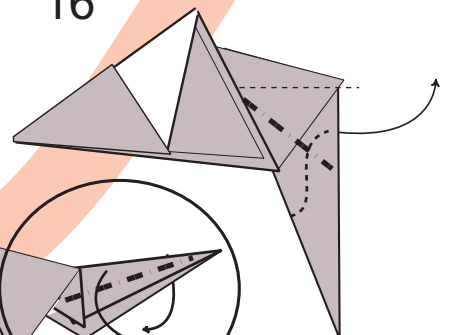

17

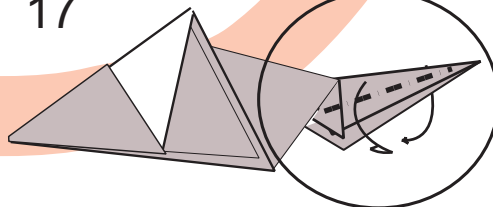

20

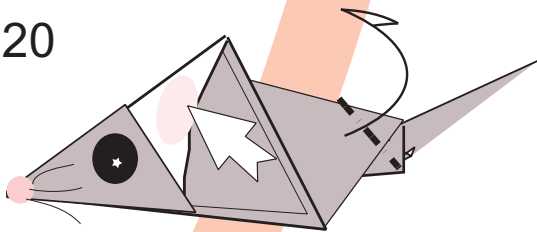

Fold behind.

Repeat on the other side.

19

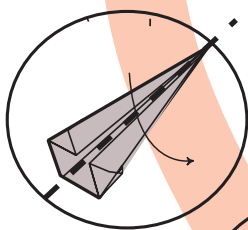

Bring the outer edge to meet to the center crease line.

18

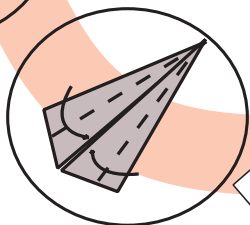

Enlarged view