

Who is hiding under the helmet?

Created by Shoko Aoyagi
Diagram by Shoko Aoyagi

© Shoko Aoyagi February 2006

You need a sheet of yellow origami paper

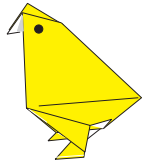
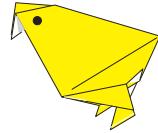
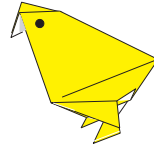
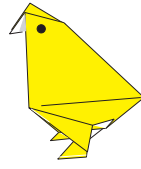
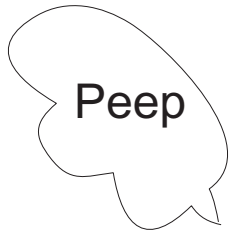
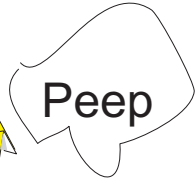
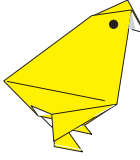
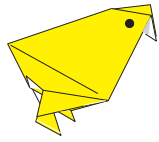

1

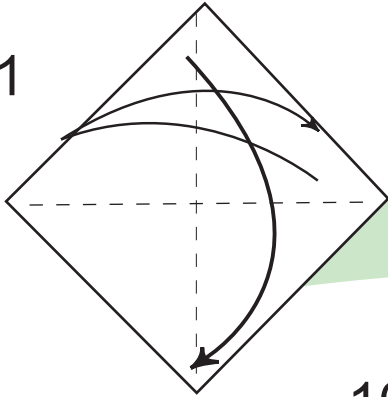

2

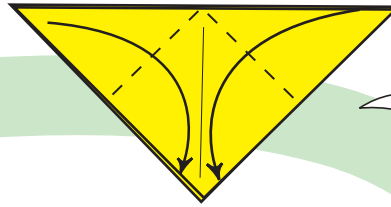

3

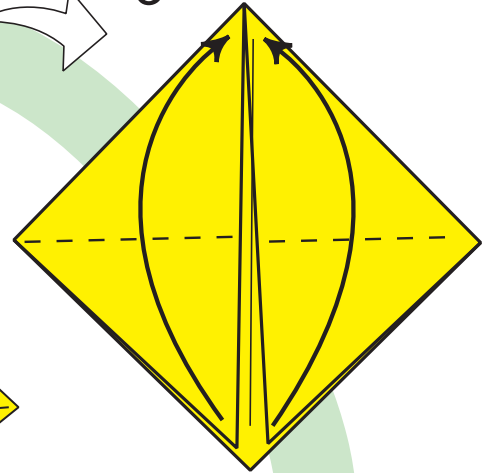

4

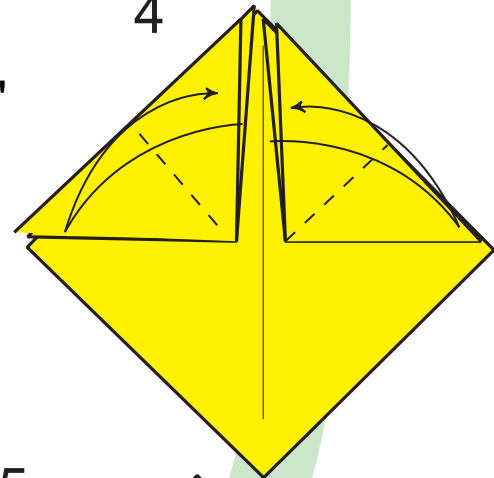

5

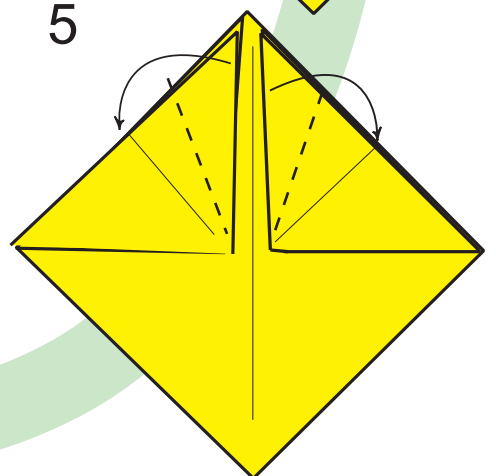

9

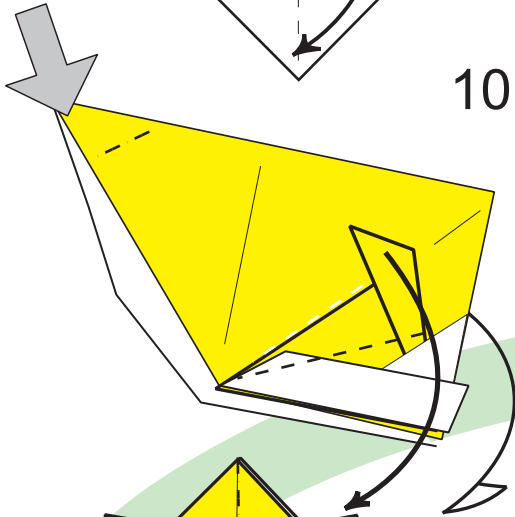

10

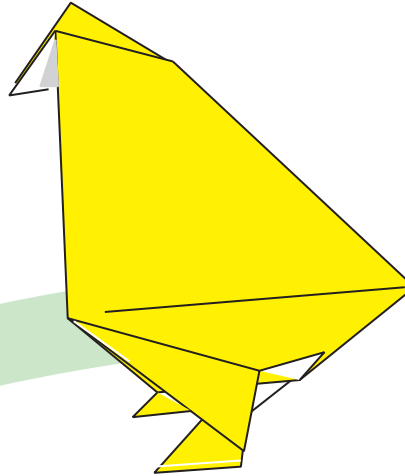

8

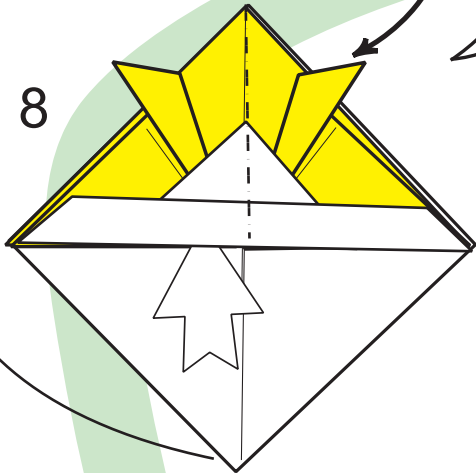

7

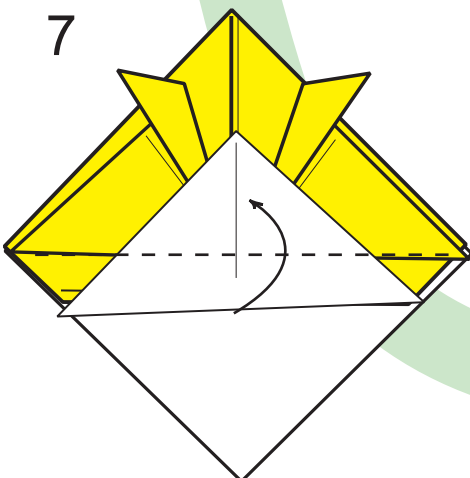

6

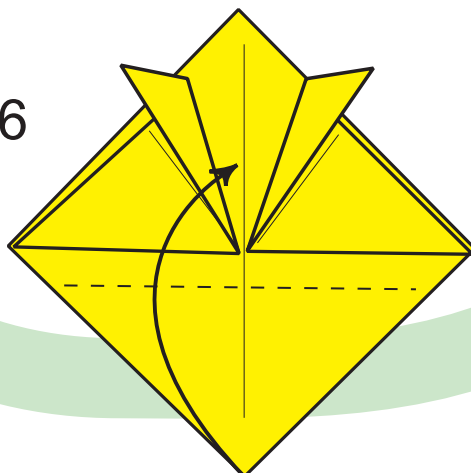

"And now if you 'peep' under the helmet, you'll find a chick hiding there!"

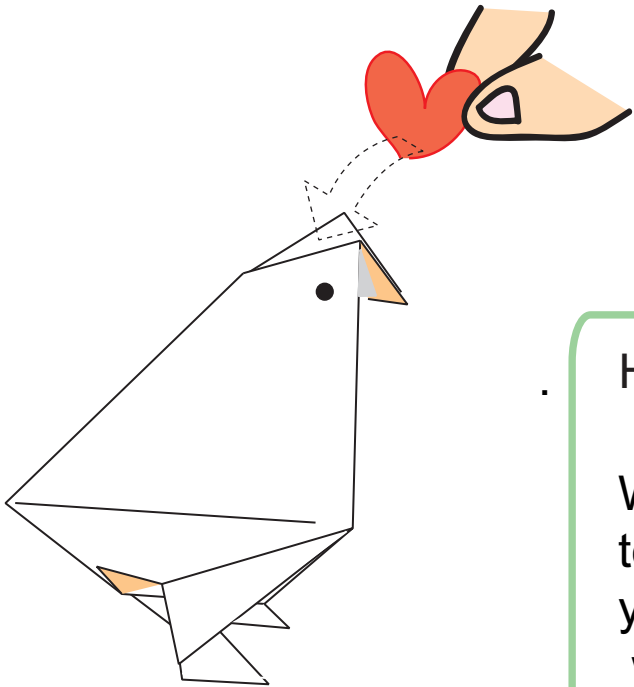

Hint:

When you attach a heart to the top of the chick's head, you create a mother hen who loves all her children.

