

Fairy penguin

© Shoko Aoyagi 2002

1/3

Created by Shoko Aoyagi
Diagrams by Shoko Aoyagi

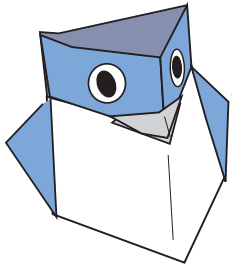

Let's make the beak first.

Origami 15x15 cm

for the beak

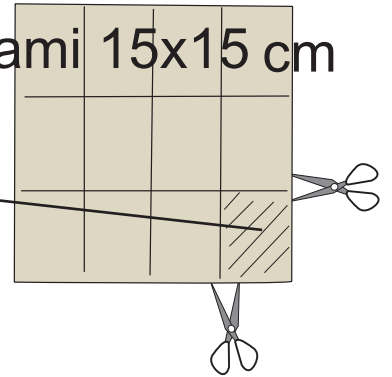

1

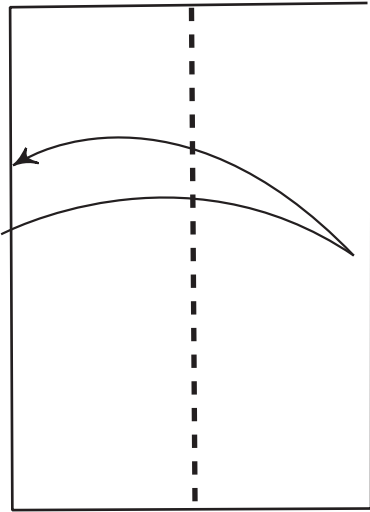

2

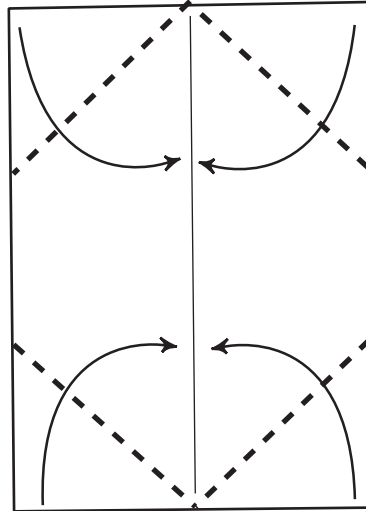

3

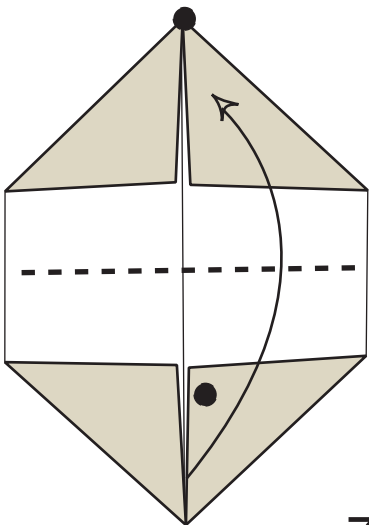

4

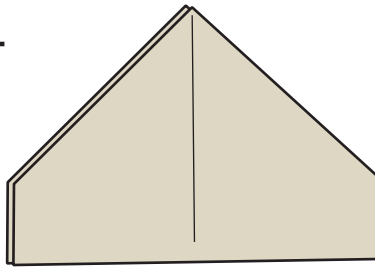

5

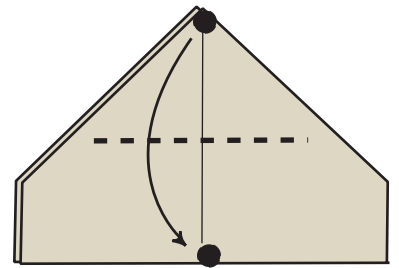

6

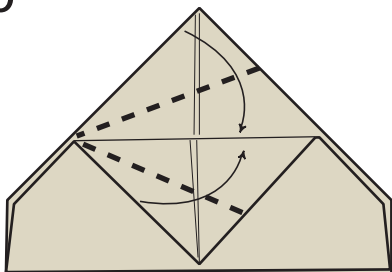

7

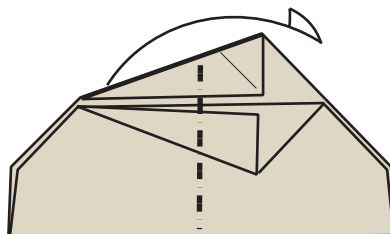

8

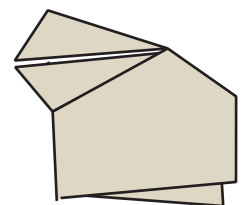
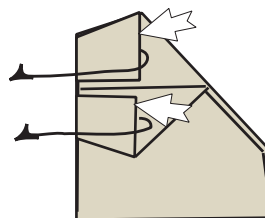

Fold behind.

Here is the penguin's beak.

Fairy penguin

Created by Shoko Aoyagi
Diagrams by Shoko Aoyagi

© Shoko Aoyagi 2002

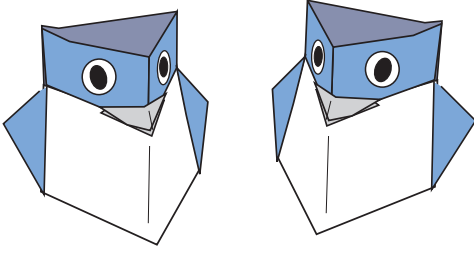

You need a sheet of black origami paper 15cm x 15cm and some grey paper for the beak as shown.

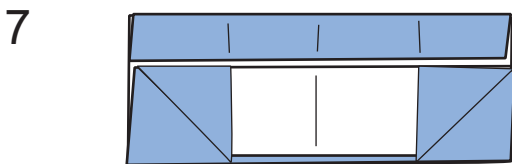
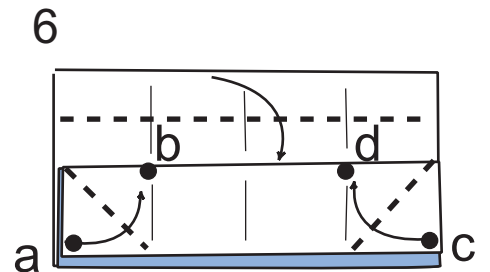
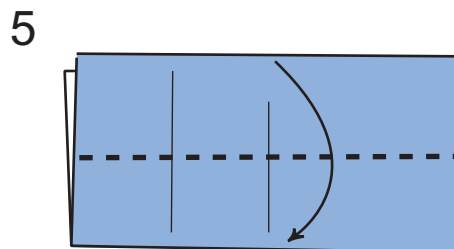
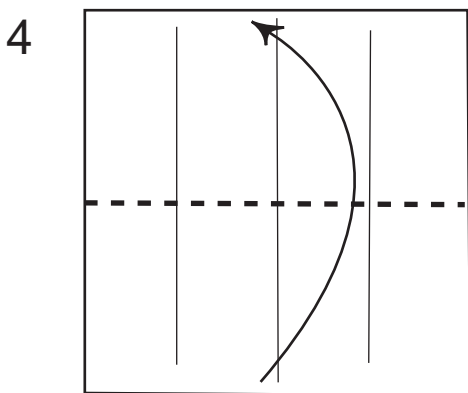
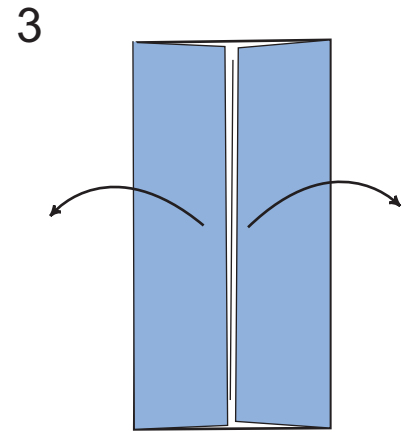
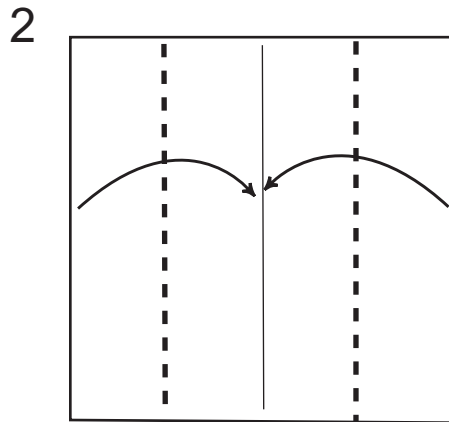
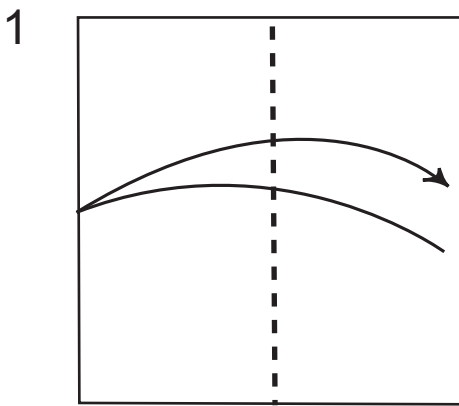

Turn it over.

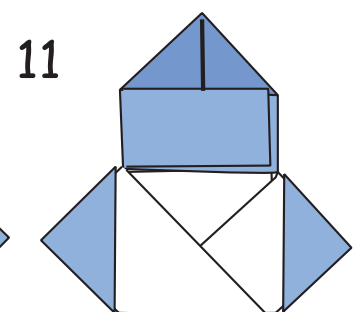
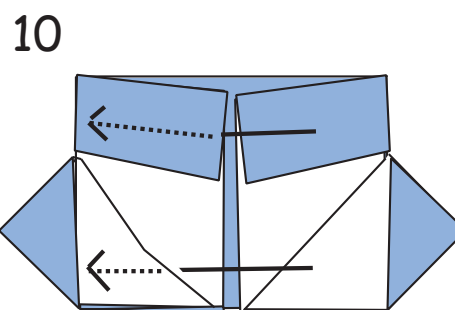
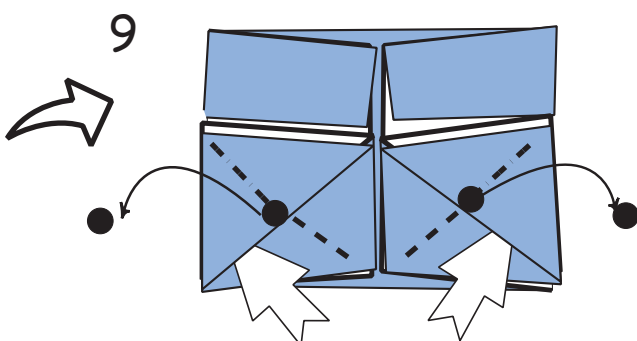
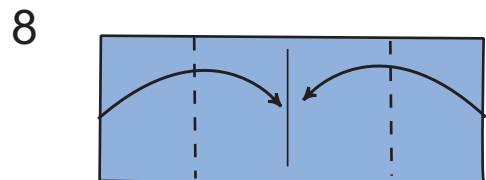

Fairy penguin

Created by Shoko Aoyagi
Diagrams by Shoko Aoyagi

© Shoko Aoyagi 2002

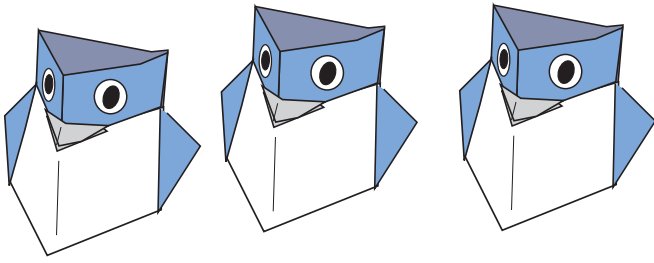

Let's assemble them.

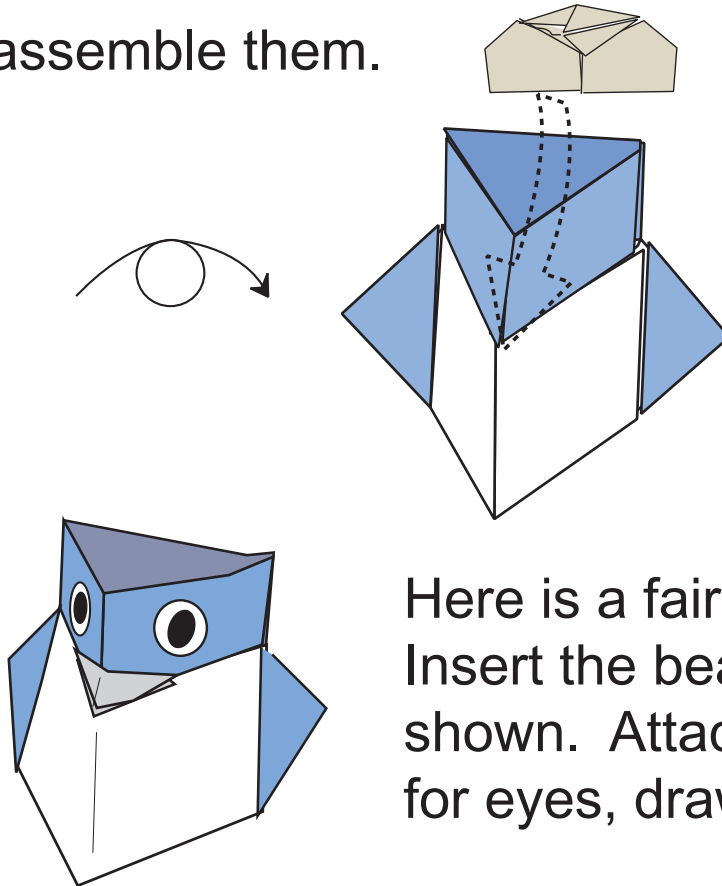

Here is a fairy Penguin.
Insert the beak under the body as
shown. Attach the round stickers
for eyes, draw eyeballs.

It is easy to assemble them in step# 7.

