

Apple

You need a sheet of origami paper.

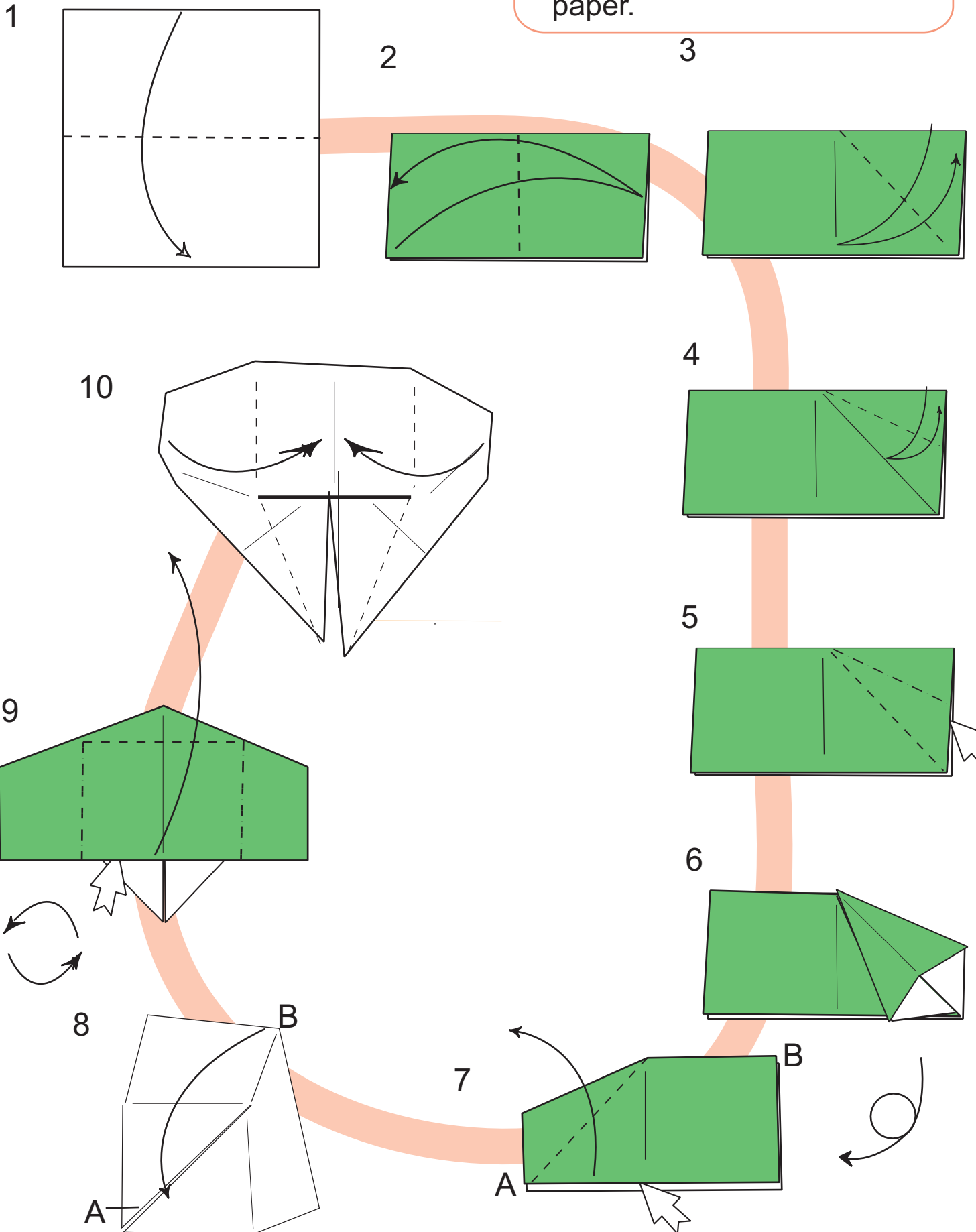

Line A should be a hinge.

Apple

11

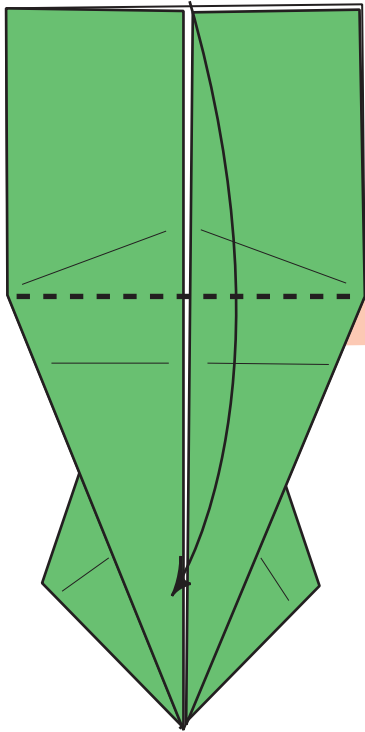

12

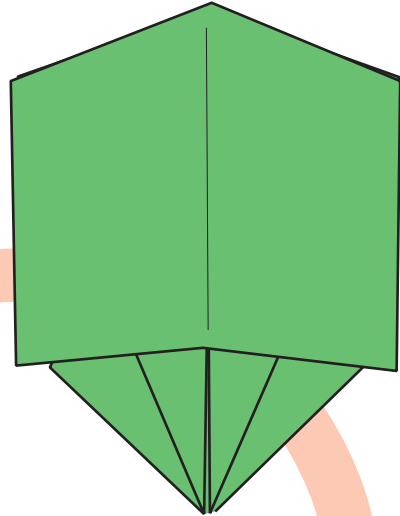

13

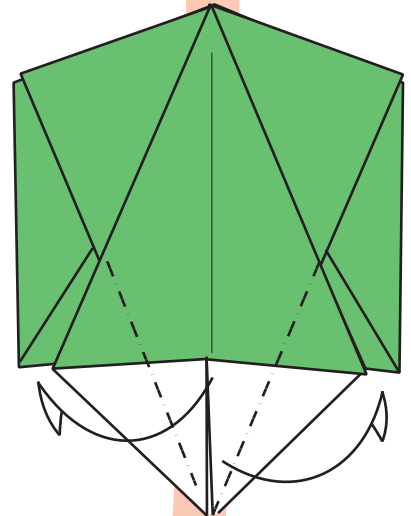

Fold back.

16

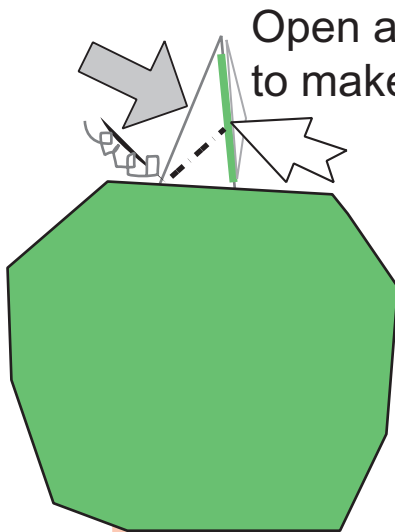

Open and squash fold to make the leaf.



15

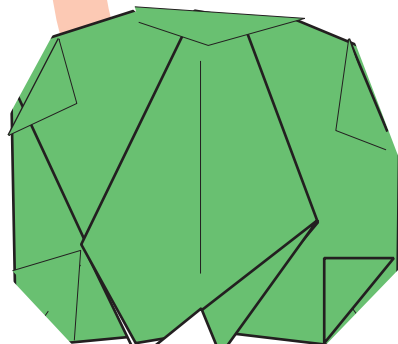

14

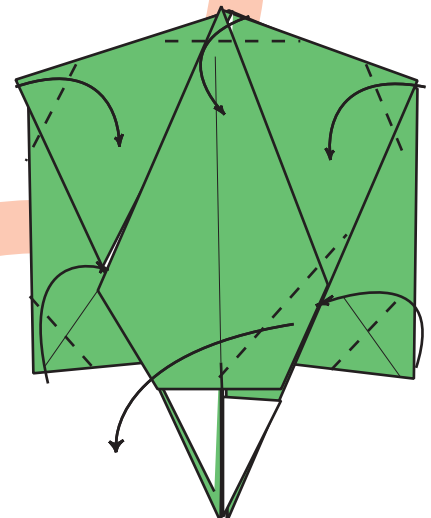

Twist this.



17

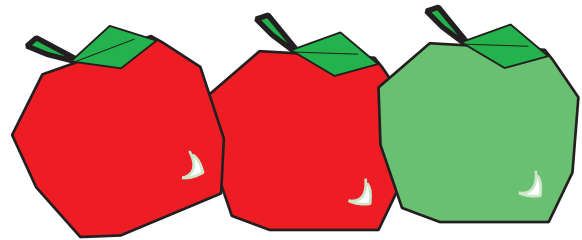
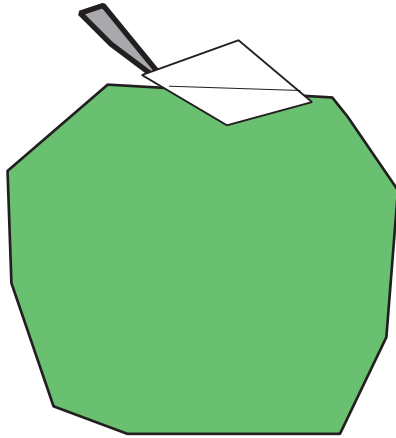

You have now an apple.

Try to fold this apple out of `duo paper`. (red and green)